

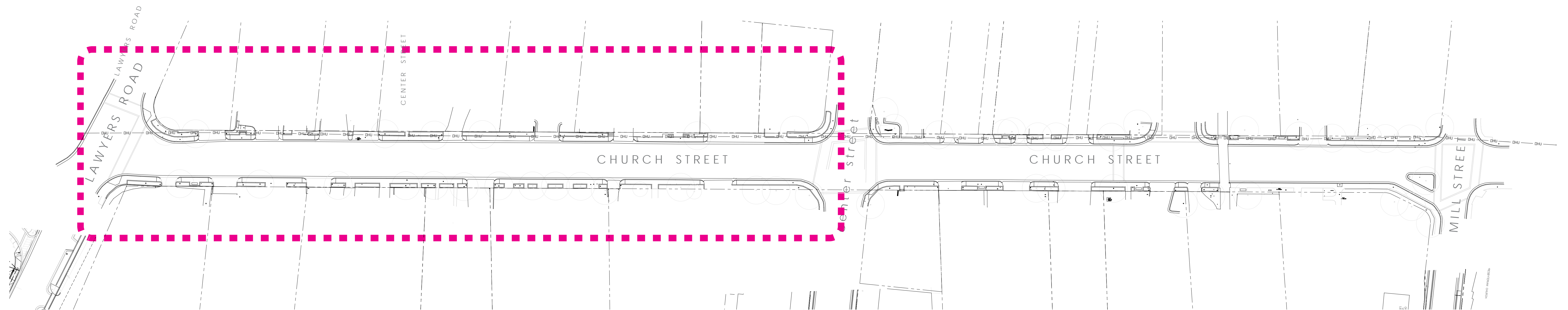

1. EXISTING CONDITIONS
2. REFINED CONCEPT
3. IMPLEMENTATION



EXAMPLE AREA



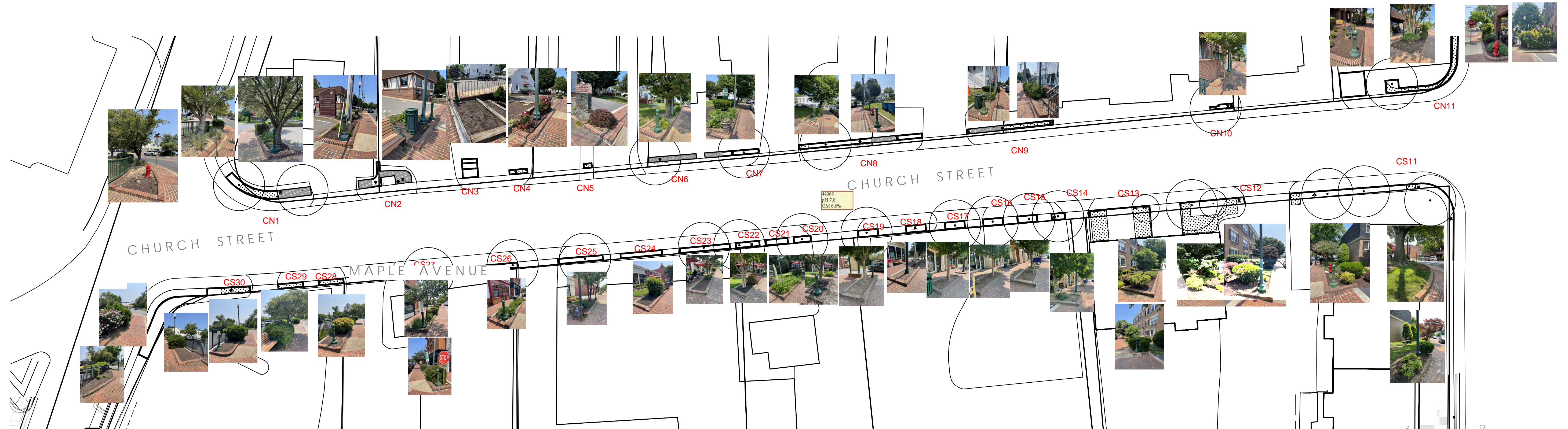

Lawyer's Road to Center Street



SOIL TEST REPORT FOR:		ADDITIONAL COPY TO:	
ARENI CROSSM LARRY WEANER LANDSCAPE ASSOC 2029 MT CARMEL AVE GLENDELE, PA 19038			
DATE	LAB #	SERIAL #	COUNTY
05/19/2023	S23-29388	44063	Montgomery
ACRES	ASCS ID	FIELD ID	SOIL
		LSG-6	
SOIL NUTRIENT LEVELS			
		Below Optimum	Optimum
Soil pH	7.0	[Bar chart showing pH 7.0 is above optimum]	
Phosphorus (P)	19 ppm	[Bar chart showing P 19 ppm is below optimum]	
Potassium (K)	215 ppm	[Bar chart showing K 215 ppm is above optimum]	
Magnesium (Mg)	160 ppm	[Bar chart showing Mg 160 ppm is above optimum]	
RECOMMENDATIONS:			
Limestone*: NONE		Magnesium (Mg): NONE	
*Calcium Carbonate equivalent			
Plant Nutrients: (If manure will be applied, adjust these recommendations accordingly. See back of report.)			
Year	Crop	Expected Yield	Nitrogen (lb N/A) Phosphate (lb P ₂ O ₅ /A) Potash (lb K ₂ O/A)
1	Other	0	0 0 0
No crop was specified. Therefore no recommendation is given.			
2	Other	0	0 0 0
No crop was specified. Therefore no recommendation is given.			
3	Other	0	0 0 0
No crop was specified. Therefore no recommendation is given.			
ADDITIONAL RESULTS:			
Calcium (ppm)	Acidity (meq/100 g)	CEC (meq/100 g)	% Saturation of the CEC
1679	0.0	10.3	5.4
			K Mg Ca
			13.0 81.7 6.6
Optional Tests:			
Organic Matter %	Nitrate-N ppm	Salts (meq/100 g)	
Trace Elements:			
Zinc (ppm)	Copper (ppm)	Sulfur (ppm)	
11.0	7.6	11.2	



44063
pH 7.0
OM 6.6%

FINDINGS:

- PLANTING BEDS INTEGRATE WITH LANDSCAPES MAINTAINED BY ADJACENT OWNERS
- LANDSCAPE IS FULL BUT IRREGULAR - LACKING RHYTHM AND REPETITION
- MAINLY PART-SHADE TO SHADE CONDITIONS
- SOIL PH SLIGHTLY ACIDIC, ORGANIC MATTER TOPPED AROUND 14%

EXAMPLE AREA

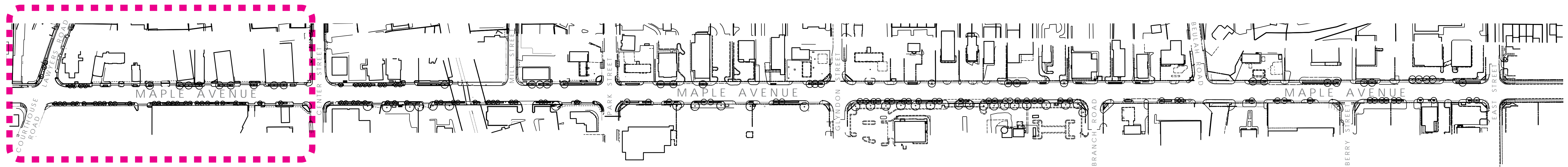

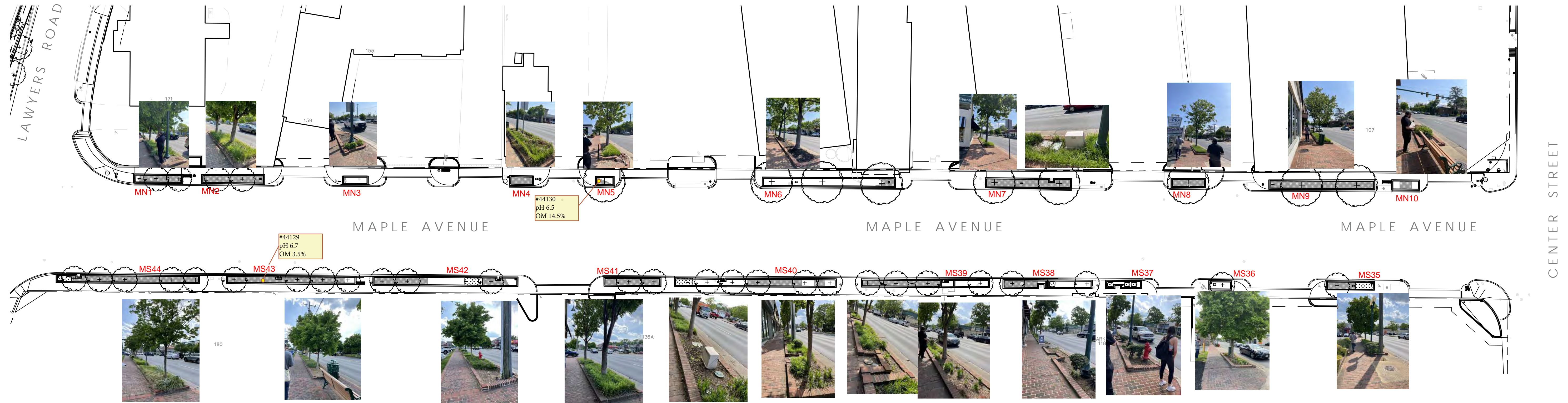

Lawyers Road to Center Street

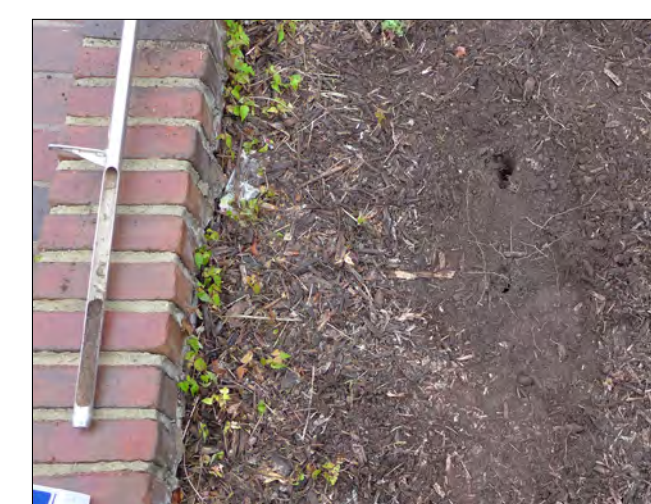

#44129
pH 6.7
OM 3.5%



Soil Test Results	
Sample ID	#44129
Location	Maple Avenue
Depth	0-10 cm
Moisture	12.5%
pH	6.7
OM	3.5%
N	0.1%
P	15 mg/kg
K	120 mg/kg
Ca	1500 mg/kg
Mg	100 mg/kg
Na	5 mg/kg
S	100 mg/kg
Cl	5 mg/kg
B	0.5 mg/kg
Cu	0.5 mg/kg
Zn	5 mg/kg
Mn	50 mg/kg
Fe	500 mg/kg



#44130
pH 6.5
OM 14.5%



Soil Test Results	
Sample ID	#44130
Location	Maple Avenue
Depth	0-10 cm
Moisture	14.5%
pH	6.5
OM	14.5%
N	0.2%
P	18 mg/kg
K	130 mg/kg
Ca	1600 mg/kg
Mg	110 mg/kg
Na	6 mg/kg
S	110 mg/kg
Cl	6 mg/kg
B	0.6 mg/kg
Cu	0.6 mg/kg
Zn	6 mg/kg
Mn	60 mg/kg
Fe	600 mg/kg

FINDINGS:

- MANY OF THE ORIGINAL MAPLE TREES REMAIN
- DENSE SURFACE ROOTS FROM MAPLE TREES FILL PLANTERS
- DENSELY ESTABLISHED LIRIOPE WITH THICK ROOT MATTING
- LIGHT POLES, SIGNS, AND OTHER UTILITIES LOCATED IN BEDS
- BEDS RANGE FROM BARE SOIL TO FULLY VEGETATED
- MAINLY PART-SHADE TO SHADE CONDITIONS, SOME FULL SUN MAINLY ON NORTH SIDE OF STREET
- SOIL PH SLIGHTLY ACIDIC, ORGANIC MATTER TOPPED AROUND 14%

EXISTING CONDITIONS - EXISTING PLANT SPECIES



Town of Vienna Existing Vegetative Cover

Botanical Name	Common Name	*Area(s) Where Present
Tree		
Acer buergerianum	Trident Maple	MN1,2,3,11,12,13,14,23,24,25,27,29,35 MS1,1A,1C,2,3,4,5,6,7,8,9,11,12,12A,12B,13,14,15,16,17,18,20,21,23,24,25,26,27,28,29,30,31,32,33,34,35,36,37,38,39,40,41,42,43,44 CN8,12A,15,17,18,19 CS4,5,9,13,14,15,16,18
Acer palmatum	Japanese Maple	CN11 CS10,11
Acer platanoides	Norway Maple	MN32
Acer rubrum	Red Maple	MN5,6,7,8,9,13,14,15,16,17,20,21,23,25A,29,31,3
Acer saccharum	Sugar Maple	MN26,32,33
Amelanchier sp.	Serviceberry sp.	MS31 CS1,26
Catalpa bignonioides	Southern Catalpa	MS31 CN1,6
Cercis canadensis	Eastern Redbud	MN14,15,18,20,33 MS27,31 CN11,12
Cornus florida	Flowering Dogwood	CN12A,12B
Cornus florida x kousa	Hybrid Dogwood	CN14
Crataegus sp.	Hawthorn sp.	MS31
Ilex opaca	American Holly	MN26 MS3
Juglans nigra	Black Walnut	MN1,2,4,13,14,18,20,21,23,24,25,29,30,31,32,34,35 MS12,14,15,16,19,21,22,24,27,30,31,32,34,35 CN12A C
Juniperus virginiana	Red Cedar	MN7,11,14,23,33 MS3,15,17,31,3
Lagerstroemia indica	Crepe-Myrtle	MN17 CN9,11 CS20,21,22,23,24
Magnolia virginiana	Sweetbay Magnolia	MS19
Malus sp.	Crabapple sp.	MN20 MS32
Morus alba	White Mulberry	MN20,26,31,34 MS1,2,8,39,4
Prunus avium	Bird Cherry	MS37
Prunus serotina	Black Cherry	MN2,7,26,33 MS3,8,12,16,26,34,36,40 CN6,11,18 CS5,7
Prunus subhirtella	Higan Cherry	MN27A
Pyrus calleryana	Callery Pear	MN1,15,18,20,33,34 MS1,7,9,18,22,23,25,26,27,28,29,31,35,36,39,42,43,4
Quercus palustris	Pin Oak	CN8,9
Quercus phellos	Willow Oak	MN12,17,18,23,34 CN15
Quercus rubra	Northern Red Oak	MN34
Quercus sp.	Oak sp.	CN19
Sassafras albidum	Sassafras	MN30
Styphnolobium japonicum	Scholar-tree	MN33 MS22
Styrax japonica	Japanese Snowbell	CN1,5,6,7 CS10,19,28
Thuja occidentalis	Eastern White Cedar	CN12
Ulmus sp.	Elm sp.	MN23,31 MS5,8,11,27,28,31
Shrub		
Abelia sp.	Abelia sp.	CS26
Berberis thunbergii	Japanese Barberry	MN26,28,29 MS9,11,15,17 CN4,11
Buxus sempervirens	Boxwood	CN8,10
Chaenomeles speciosa	Flowering Quince	MN13,23 MS24
Chamaecyparis pisifera	Sawara False-Cypress	MN15,20,23 MS1,20,23
Clethra alnifolia	Summersweet	MS16
Euonymus alatus	Burningbush	MN23
Hypericum calycinum	Aaron's Beard	MN34 MS14,18
Ilex cornuta	Chinese Holly	M17,18,32,34 MS13,16,18 CS1,25
Ilex crenata	Japanese Holly	MN14,19 MS12,31,32,35,37,38,39,42,44 CN11,11
Ilex glabra	Hollyberry	MN24 MS8 CS3
Juniperus sp.	Juniper sp.	MN14 MS13,21 CS4,11,12
Lavandula angustifolia	English Lavender	CS25,26
Lonicera maackii	Amur Honeysuckle	MN1,6,7,15,19,20,21,23,25A,32,33,34,35 MS2,5,8,11,15,17,18,20,22,23,25,26,30,32,34,37,40 CN8,13,14,15 CS1
Nandina domestica	Heavenly Bamboo	MN22*,31,33,35 MS10,12,19 CN10,12 CS10,27,2
Prunus laurocerasus	English Cherry Laurel	CS5,10,12
Physocarpus opulifolius	Common Ninebark	MN14
Rosa sp.	Rose sp.	CN3 CS21,29
Spiraea japonica	Japanese Spirea	MN10,33 MS11 CN12A CS3
Viburnum dentatum complex	Arrowwood Viburnum complex	CS13
Woody Vine		
Ampelopsis glandulosa var. brevipedunculata	Porcelainberry	MN1,7,23,33,35 MS2,8,13,16,17,18,19,24,26,27,28,29,30,35,40,43 CN5,8,9,11,15 CS1,2
Celastrus orbiculatus	Oriental Bittersweet	MN24,30,34 MS2,11,12,19,22,26,27,30,33 CN1
Clematis terniflora	Sweet Autumn Clematis	MS2
Euonymus fortunei	Wintercreeper	MN25,34 MS2,13,17,18,35,39,42,44 CN5,7,13,11
Hedera helix	English Ivy	MN34,11 MS13,18,26,39,41,42 CN8,13,15 CS5,1
Parthenocissus quinquefolia	Virginia Creeper	MN20 MS3,11,18,19,22,35,42 CN7,15,18 CS10,2
Parthenocissus tricuspidata	Boston Ivy	MN6 MS19
Smilax sp.	Greenbriar sp.	MN11 CN6
Toxicodendron radicans	Poison Ivy	MN31,33,34 MS9,23,26,27
Forb		
Acalypha rhomboidea	Three-seeded Mercury	CN8
Aegopodium podagraria	Goutweed	CN3
Allium vineale	Field Garlic	MN12,16,17 MS32
Arachis hypogaea	Peanut	MN18
Arenaria serpyllifolia	Thyme-leaved Sandwort	MN11,14 MS1A,26,27
Artemisia vulgaris	Mugwort	MN7,16 MS22,31
Asclepias syriaca	Common Milkweed	MS12
Bidens sp.	Beggarticks sp.	CS22
Cardamine hirsutus	Hairy Bittercress	MN18,27,30 MS13,16
Centaurea cyanus	Bachelor's Buttons	CN1,CN16 CS6,9
Cerastium fontanum	Mouse-eared Chickweed	MN23,32,35 MS1B,12
Chenopodium sp.	Goosefoot sp.	CN13
Chrysanthemum sp.	Mums sp.	CN16 CS29
Commelina communis	Asiatic Dayflower	MN30 CS23
Coneopsis sp.	Tickseed sp.	CN8 CS1
Coreopsis verticillata	Whorled Coreopsis	MS31 CN2,5,6,15 CS1,8,12,24
Echinacea purpurea	Purple Coneflower	MN3,12,14,32 MS14,19,33,31 CN2,5,6,7,8 CS1,7,8,9,25,2
Erechtites hieracifolia	Pilewort	MN14,33
Erigeron philadelphicus	Philadelphus Fleabane	MS1
Euphorbia (Chamaesyce) sp.	Sandmat sp.	MN25B,32

Town of Vienna Existing Vegetative Cover

Botanical Name	Common Name	*Area(s) Where Present
Tree		
Galium aparine	Cleavers	MS34 CN6
Geranium carolinianum	Carolina Geranium	MN26,35 MS16 CN14
Hemerocallis 'Stella de Oro'	Stella de Oro Daylily	MN21,32,33,35 MS2,3,16,18,20,21,25 CN7,14 CS2,3,4,9,20,25,2
Hosta sp.	Plantain Lily sp.	MS33,34,40 CS9
Hyacinthus orientalis	Hyacinth	MS39 CN3
Hydrotylephium spectabile	Showy Stonecrop	MS11,12,23,31,34 CN11
Iris sibirica	Siberian Iris	CN2
Iris x germanica	Bearded Iris	CN1
Lactuca serriola	Prickly Lettuce	MN1,6,11,13,14,15,18,32,33,35 MS3,8,11,15,16,17,20,21,23,34,4
Lamium amplexicaule	Henbit	MN11,12,13,14,23,27,31,32,33 MS8,42 CN1
Lepidium sp.	Pepperweed sp.	M14 MS44
Leucanthemum vulgare	Ox-eye Daisy	MS13
Leucanthemum x superbum	Shasta Daisy	CN1 CS1
Liatris spicata	Dense Blazing Star	MN29,30,31
Liriope muscari	Clumping Lilyturf	MN1,25,34 MS4,13,20,36,39 CN5,6,7,11,13,14,15,16,17,18,19 CS1,4,5,8,11,12,13,14,15,16,22,2
Liriope spicata	Creeping Lilyturf	MN1,2,4,5,6,7,8,9,12,13,14,15,16,22*,24,31,32 MS5,6,7,8,21,23,24,25,26,27,28,29,30,31,32,33,34,35,38,39,40,41,42,43,44 CN12,12A,14 CS11
Mollugo verticillata	Carpeweed	MS1A
Muscari sp.	Grape Hyacinth sp.	MN13
Narcissus sp.	Daffodil sp.	MN1,2,6,7,9,10,11,12,13,14,15,16,26,32 MS3,4,8,9,12,13,14,16,17,20,21,22,23,27,28,29,31,32,33,34,38,39,40,41,43,44 CN7,13,14,15,16,17 CN3 CS4,6,7,8,14,15,20,21,22,26
Nepeta x faassenii	Blue Catmint	MN12,17,18,33 CN16 CS8,9
Nothoscordum bivalve	Crowpoison	MN29,30
Nuttallanthus canadensis	Old-field Toadflax	MN16
Oxalis sp.	Wood Sorrel sp.	MN11,13,14,25A,26,27A,32,33,34,35 MS1,3,37,40 CN14 CS
Phytolacca americana	Pokeweed	MS25 CN7
Plantago lanceolata	English Plantain	MN8,34 MS3,9
Plantago major	Common Plantain	MN15
Platycodon grandiflorum	Balloonflower	MN12,16,30,33,35 MS2,3,13,16,24,31
Polygonum aviculare	Prostrate Knotweed	MN32 MS34
Ranunculus abortivus	Kidneyleaf Buttercup	MN26
Rudbeckia fulgida	Black-eyed Susan	MN10 CN16 CS3,12,25,26
Rumex crispus	Yellow Dock	MS3
Salvia nemorosa	Wood Sage	CS22,23,24
Saponaria officinalis	Bouncing Bet	MS27
Scleranthus annuus	Knawel	MN23
Sedum sp.	Stonecrop sp.	CN1
Senecio vulgaris	Common Groundsel	MN11,12,13,14,15,16,19,21,23,24,25A,26,29,32,33,34,35 MS1,18,7,8,9,11,15,22 CN1
Solanum carolinense	Carolina Horse-nettle	MN13,17,35 CN4 CS25
Sonchus asper	Prickly Sow-thistle	MN7,11,15,18,27A,29,31,33 MS2,11,12,12A,15,34,37,43 CN12
Sonchus oleraceus	Annual Sow-thistle	MN23 MS26,27
Stellaria media	Common Chickweed	MN11,14,17,23,25A,29,32 MS1,3,8,11,12A,13,16,17,20,31,34 CS1
Symphoricarichum lanceolatum	Panicled Aster	MN31 MS2,18
Symphoricarichum pilosum	Frost Aster	MN23 MS2
Taraxacum officinalis	Common Dandelion	MN2,7,8,11,12,13,15,18,19,22,23,26,29,31,32,33,34,35 MS1,3,8,15,17,27,31,32,33,34,39,40 CN9,12A CS7
Tradescantia virginiana	Virginia Spiderwort	MN34
Tragopogon sp.	Salsify sp.	CN12B
Trifolium dubium	Least Hop Clover	MN3,33,34 MS8,9 CS13
Trifolium repens	White Clover	MN33,34 MS1,3
Tulipa sp./cv.	Tulip sp./cv.	MN1,12,13,14,17,20,21,26,31,32,33 MS4,5,11,12,13,14,15,17,23,24,25,27,30,31,32,33,34,35,38 CN5,7,9,12B,13,14,18,19 CS4,9,20,22
Veronica arvensis	Corn Speedwell	MN20 MS12,12A CN14
Veronica peregrina	Parslane Speedwell	MN14 MS3
Vinca major	Greater Periwinkle	CN15 CS20
Vinca minor	Periwinkle	CN12A,12B CS13
Viola sororia	Common Blue Violet	CN5,7
Yucca filamentosa	Adam's Needle Yucca	MN30 CN2
Zinnia elegans	Zinnia	MN14
Herbaceous Vine		
Calyptegia sepium	Hedge Bindweed	MN29 CS3
Vicia sativa	Common Vetch	MN17 MS18,32
Grasses, Sedges, and Rushes		
Anthoxanthum odoratum	Sweet Vernal Grass	MN31
Bromus inermis	Smooth Brome	MN34 MS20
Bromus tectorum	Cheatgrass	MN31 MS16
Cynodon dactylon	Bermudagrass	MN34
Cyperus esculentus	Yellow-nutsedge	MN13,14,32 MS8,25,43 CN4,12
Dactylis glomerata	Orchardgrass	MN4 MS2,42 CS5
Digitaria sp.	Crabgrass sp.	MN11,18,25,25B,30,33
Festuca arundinacea	Tall Fescue	MN1,2,4,7,8,14,15,19,21,23,29,31,32,34,35 MS2,3,6,7,13,15,20,21,40,41,42,43,4
Juncus effusus	Soft Rush	MS5
Lolium perenne	Perennial Rye	MN23
Pennisetum alopecuroides	Fountaingrass	MN20 MS11 CS3
Poaaceae	Grass sp.	MN3,25A,27A,33,35 MS1A,9,11,13,15,16,17,26,27,29,36,37,4
Poa annua	Annual Bluegrass	MN14,16,26,32 MS3,7,39 CN1C
Poa pratensis	Kentucky Bluegrass	MN5,8,9,11 MS12,16,17,21,22,28,29,38,40,4
Secale cereale	Winter Rye	MS12

*Plants match adjacent business plantings

Forb	Common Name	*Area(s) Where Present
Acalypha rhomboidea	Three-seeded Mercury	CN8
Aegopodium podagraria	Goutweed	CN3
Allium vineale	Field Garlic	MN12,15,17 MS32
Arachis hypogaea	Peanut	MN18
Arenaria serpyllifolia	Thyme-leaved Sandwort	MN11,14 MS1A,26,27
Artemisia vulgaris	Mugwort	MN7,16 MS22,31
Asclepias syriaca	Common Milkweed	MS12
Bidens sp.	Beggarticks sp.	CS22
Cardamine hirsutus	Hairy Bittercress	MN18,27,30 MS13,16
Centaurea cyanus	Bachelor's Buttons	CN1,CN16 CS6,9
Cerastium fontanum	Mouse-eared Chickweed	MN23,32,35 MS1B,12
Chenopodium sp.	Goosefoot sp.	CN13
Chrysanthemum sp.	Mums sp.	CN16 CS29
Commelina communis	Asiatic Dayflower	MN30 CS23
Coreopsis sp.	Tickseed sp.	CN8 CS1

MAPLE AVE & CHURCH ST STREETSCAPE

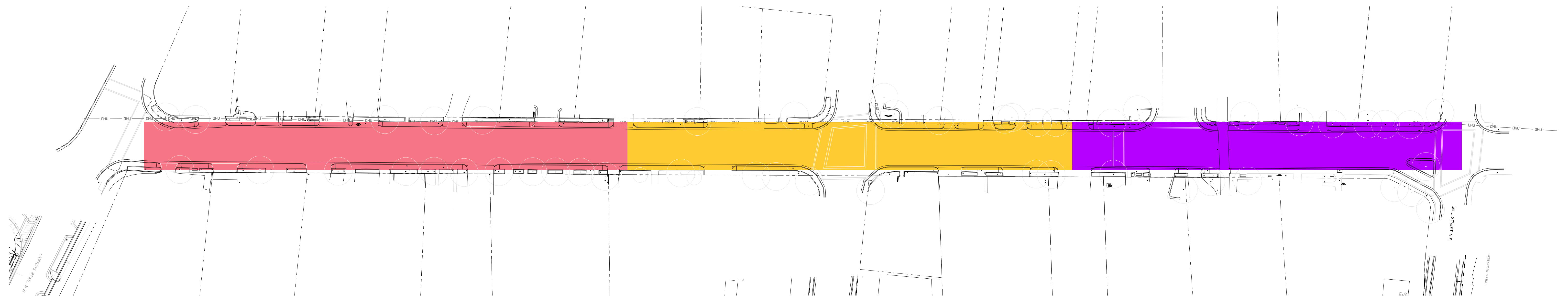

EXAMPLE AREA : PURPLE

EXAMPLE AREA : PINK

EXAMPLE AREA : YELLOW

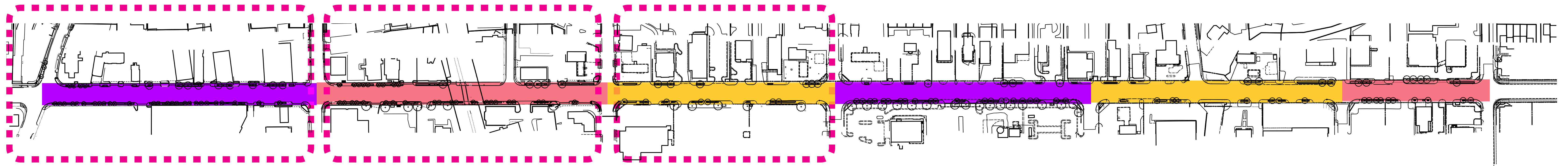

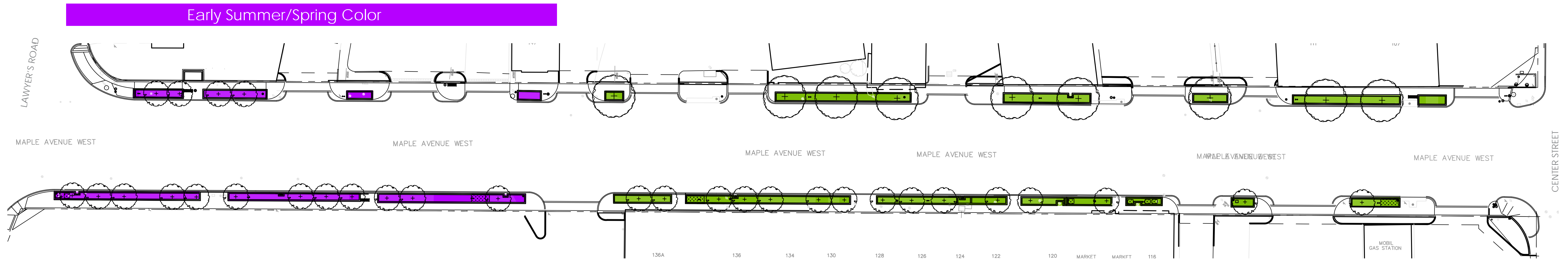

Amsonia ciliata
Fringed Bluestar



Nepeta x faassenii 'Walker's Low'
Hybrid Catmint

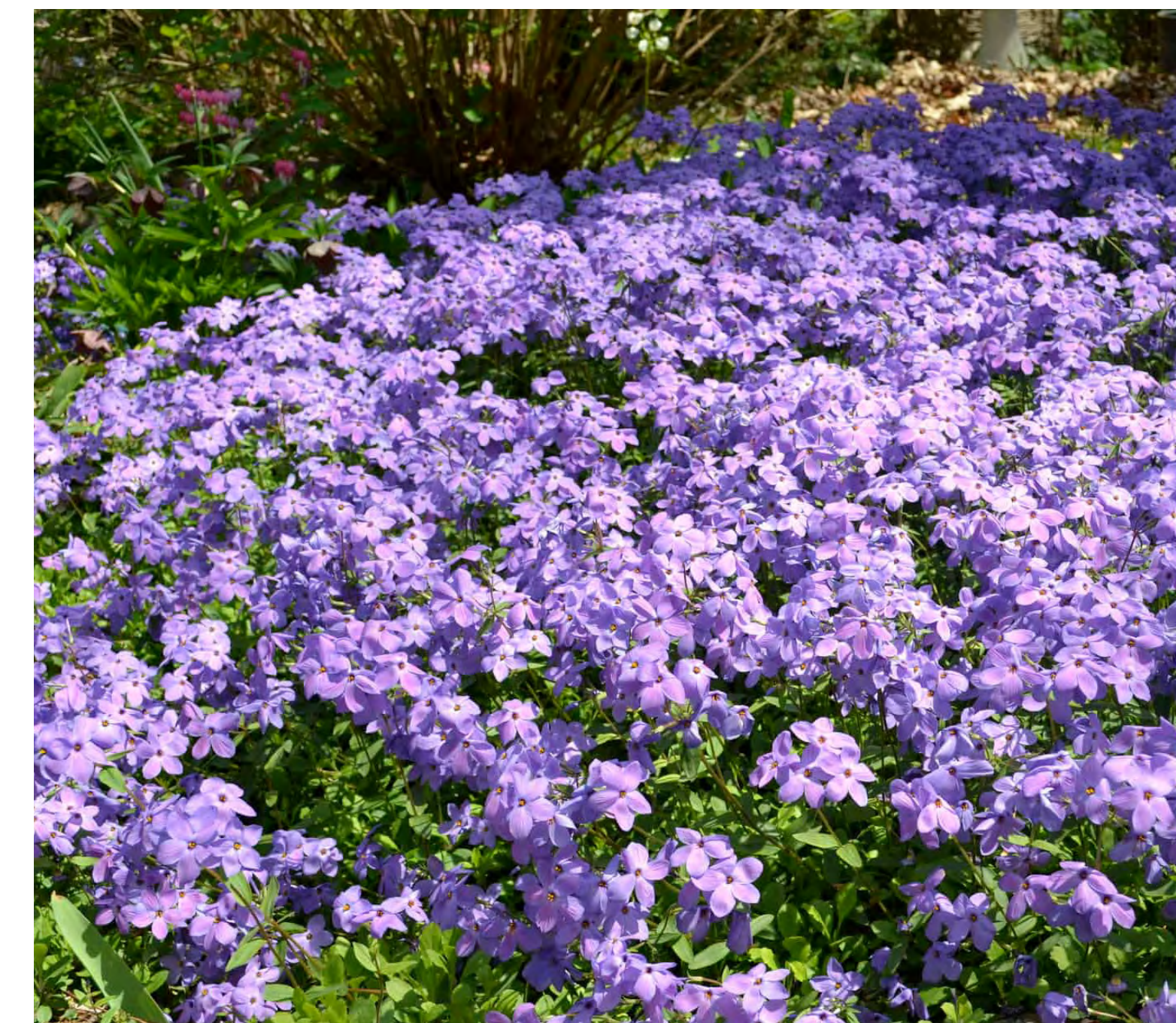

Phlox stolonifera
Creeping Phlox



Monarda bradburiana
Bradbury's Beebalm

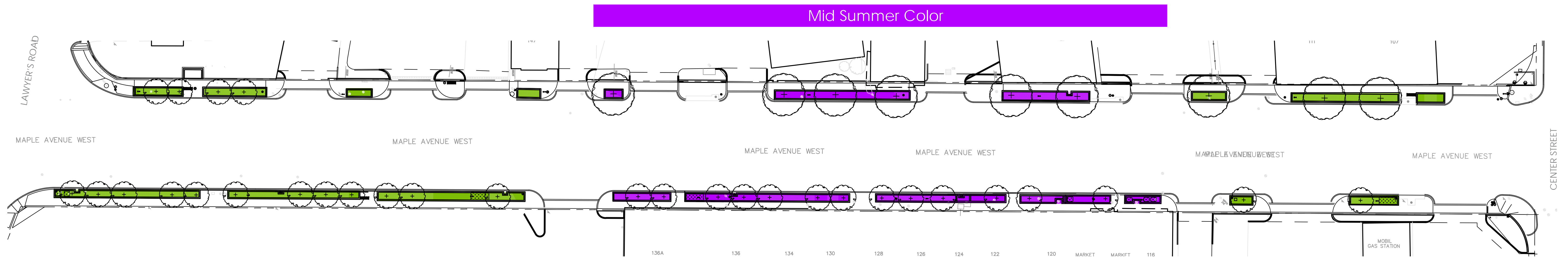

Salvia nemerosa 'May Night'
Wood Sage



Penstemon digitalis 'Huskers Red'
White Beardtongue



Geranium 'Rozanne'
Rozanne Geranium



Allium 'Purple Sensation'
Ornamental Onion

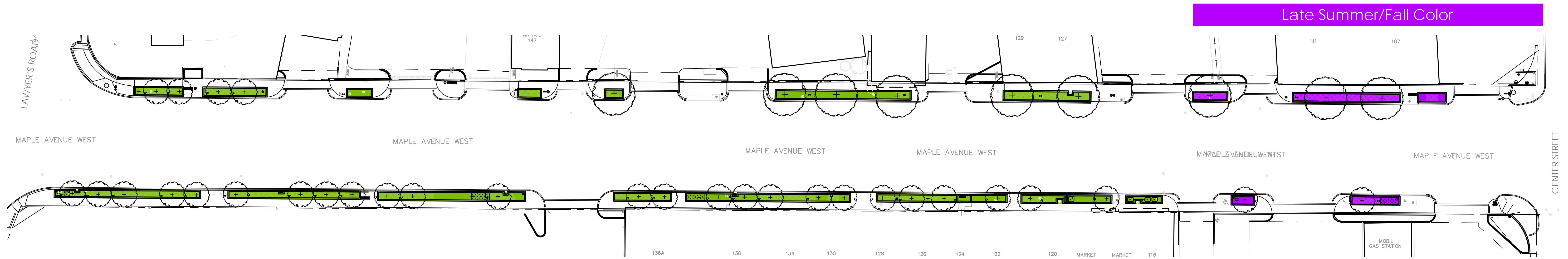

Aster cordifolius
Blue Wood Aster



Eupatorium coelestinum
Mistflower



Heuchera villosa f. purpurea 'Bronze Wave'
Hairy Alumroot



Physocarpus opulifolius 'Tiny Wine'
Dwarf Ninebark

Early Summer/Spring Color

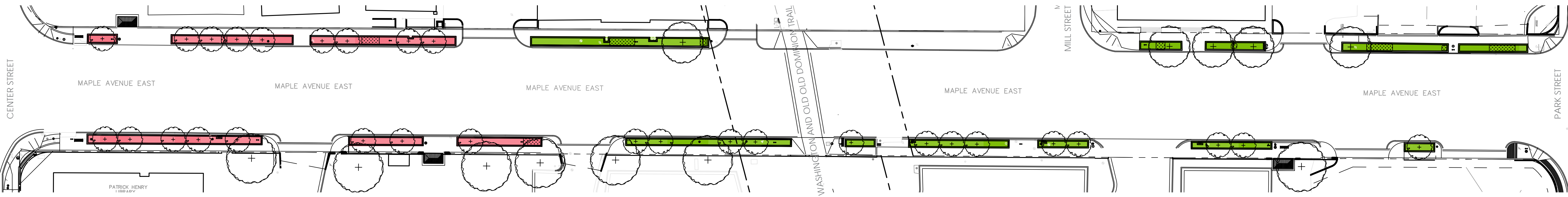

Geranium macrorhizum
Bigroot Geranium



Phlox glaberrima 'Morris Berd'
Smooth Phlox



Astilbe andresii
False Goatsbeard



Helleborus orientalis
Lenten Rose

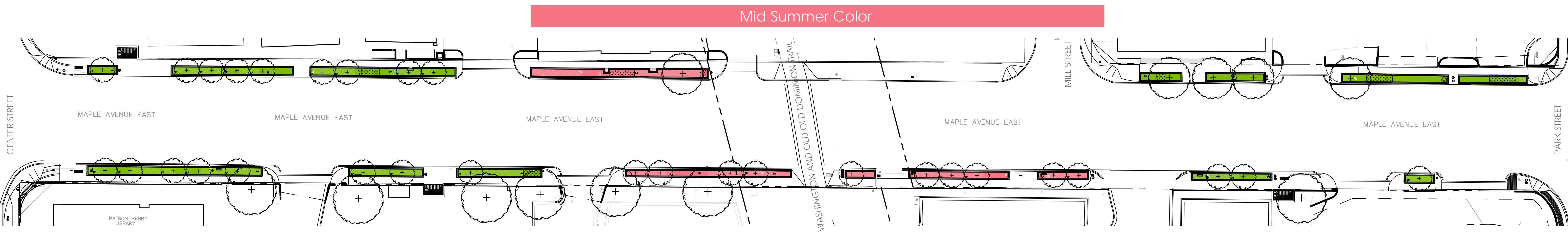

Echinacea purpurea 'Sensation Pink'
Purple Coneflower



Hydrangea paniculata 'Flare'
Peegee Hydrangea



Rosa 'Coral'
Flower Carpet Coral Rose



Allium cernuum
Nodding Pink Onion

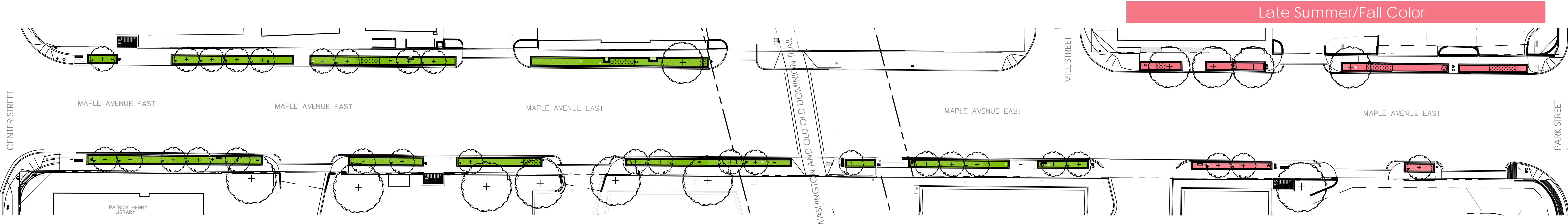

Spiraea japonica
Japanese Spiraea



Dicentra eximia
Wild Bleeding Heart



Heuchera villosa f. purpurea 'Bronze Wave'
Hairy Alumroot



Pycnanthemum tenuifolium
Slender Mountain Mint

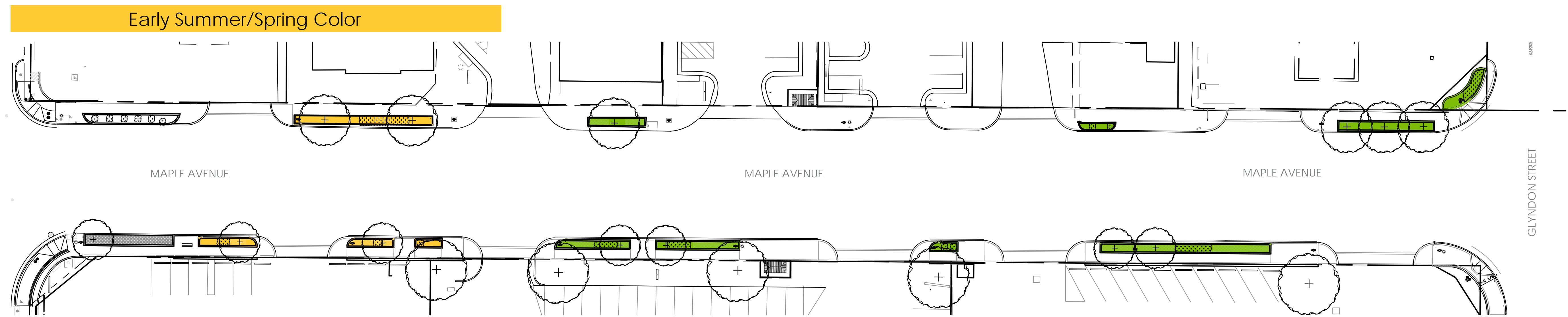

Narcissus 'Thalia'
Triandrus Daffodil



Waldsteinia fragarioides
Barren Strawberry



Senecio aureus
Golden Groundsel



Coreopsis auriculata
Mouse Ear Tickseed

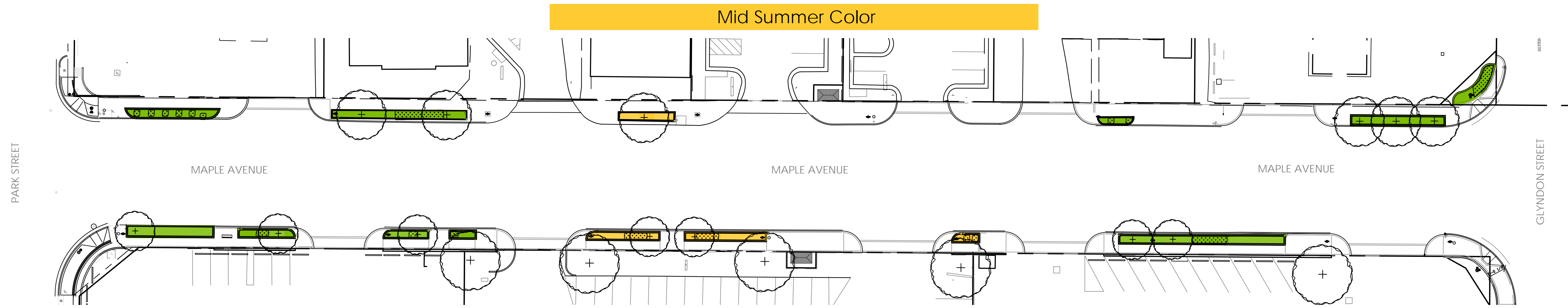

Hemerocallis 'Stella de Oro'
Stella de Oro Daylily



Hypericum calycinum
Creeping St. Johnswort



Hypericum prolificum
Shrubby St. Johnswort



Lysimachia lanceolata f. purpurea
Lance-leaved Loosestrife

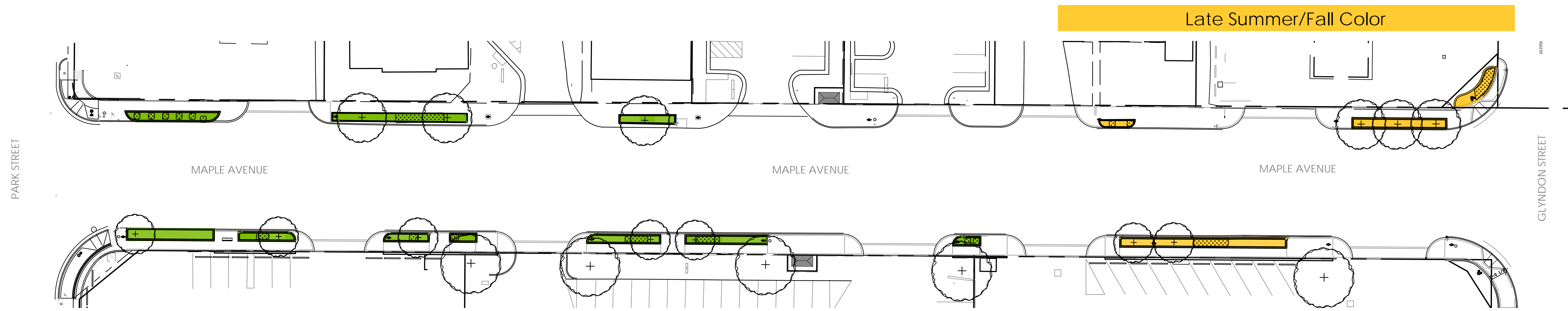

Rudbeckia fulgida var. fulgida
Black Eyed Susan



Coreopsis auriculata
Mouse Ear Tickseed



Rudbeckia fulgida var. speciosa
Black Eyed Susan



Schizachyrium scoparium 'Standing Ovation'
Little Bluestem



GROUND COVER
BRICK CURB
MULCH

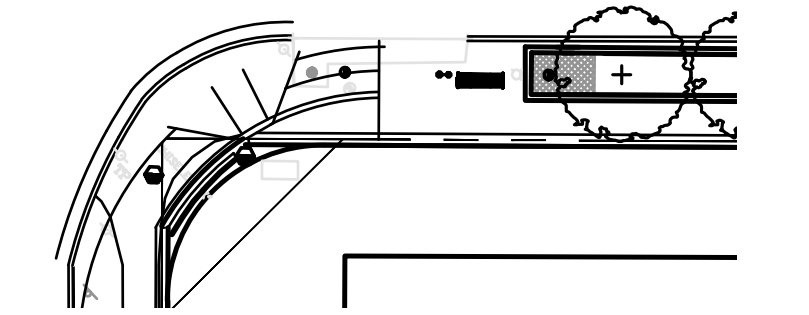
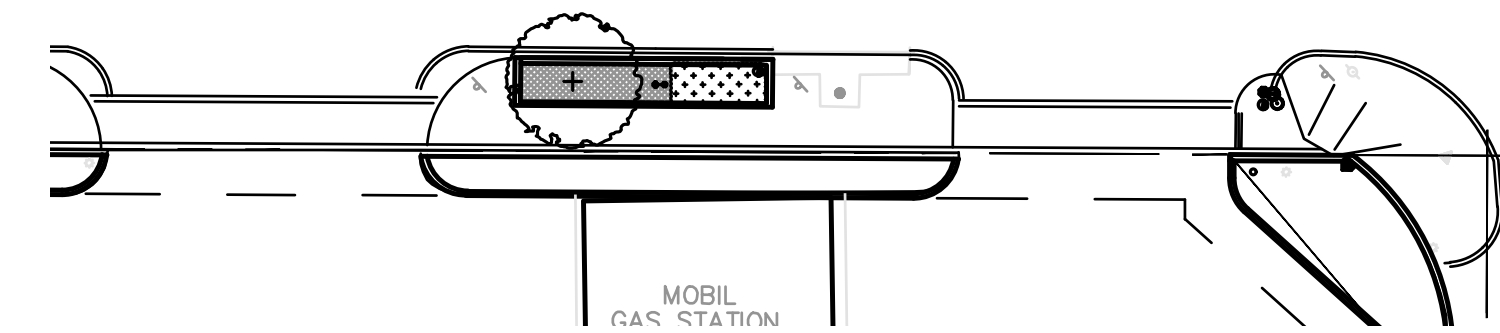
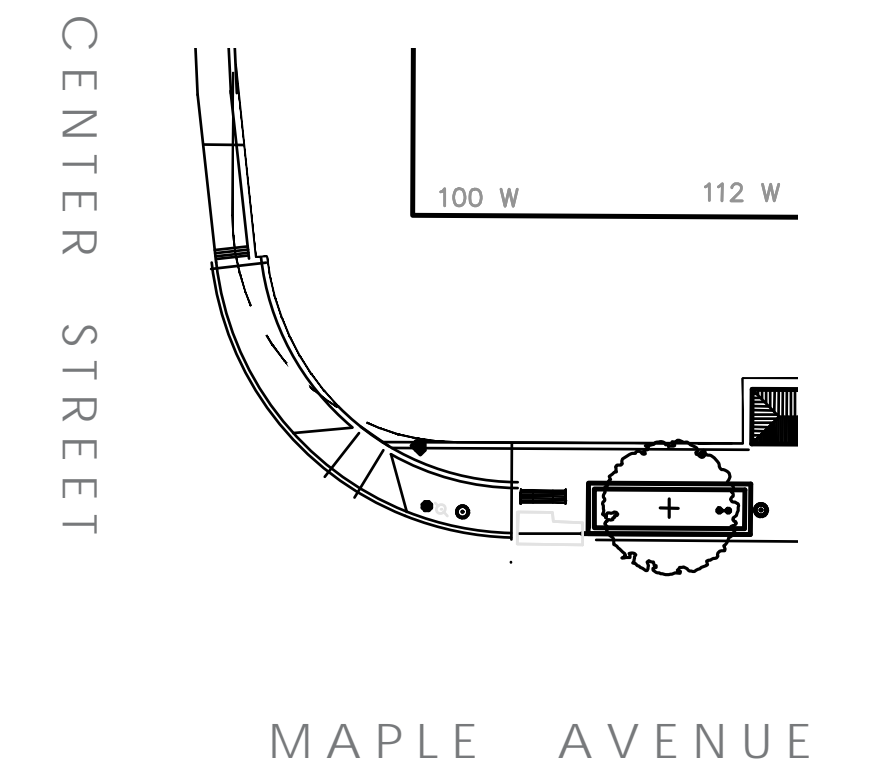
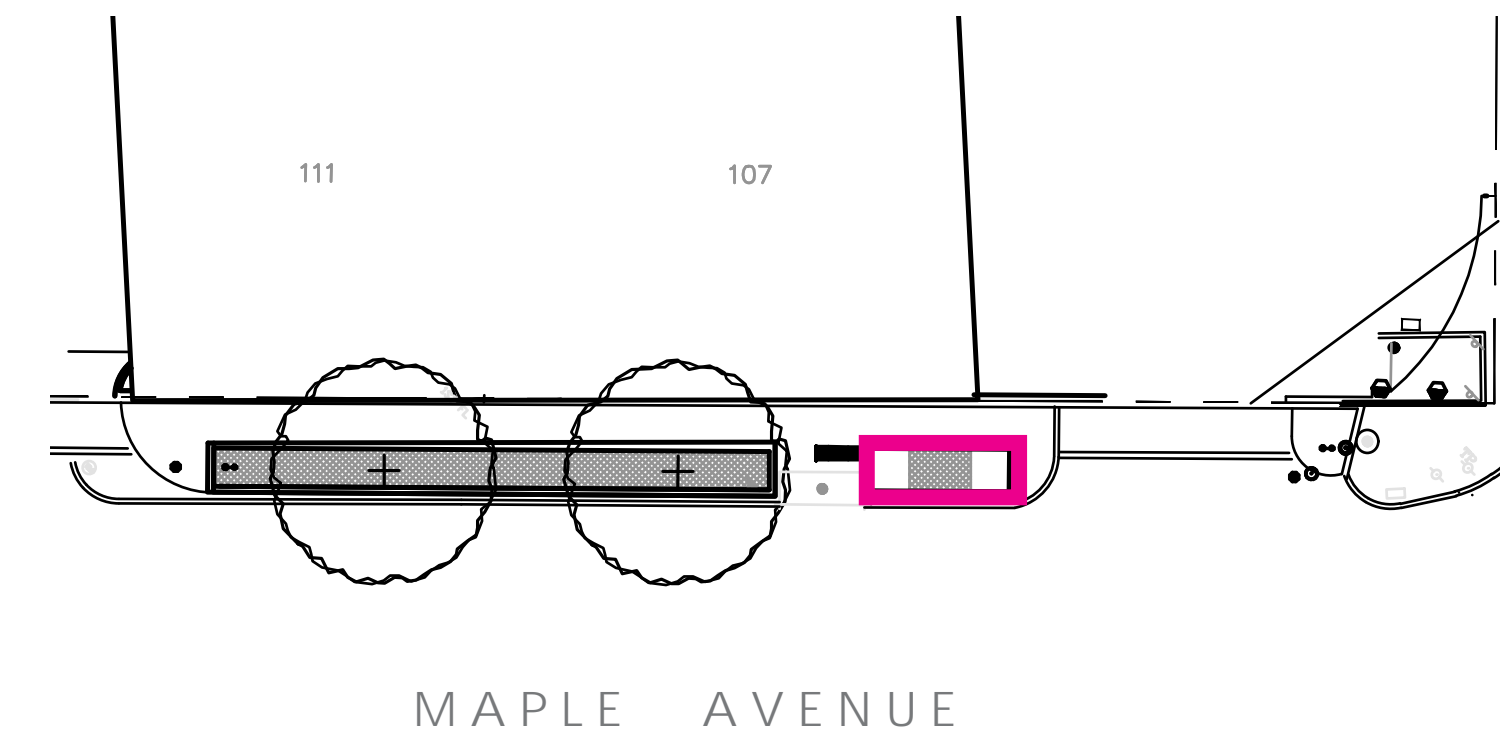

CONDITION A

- PRIMARILY NORTH SIDE OF MAPLE AVE.
- AREAS BETWEEN TREE CANOPIES AND IN BEDS WITH NO TREES
- SOME SHRUBS AND GROUND COVER PRESENT, OTHER AREAS DEVOID OF PLANTING
- MOST FAVORABLE CONDITION FOR ESTABLISHMENT OF FLOWERING PERENNIALS



NEW PLANTING
 2" MULCH
 18" AGITATED SOIL + AMENDED SOIL (AS NEEDED)

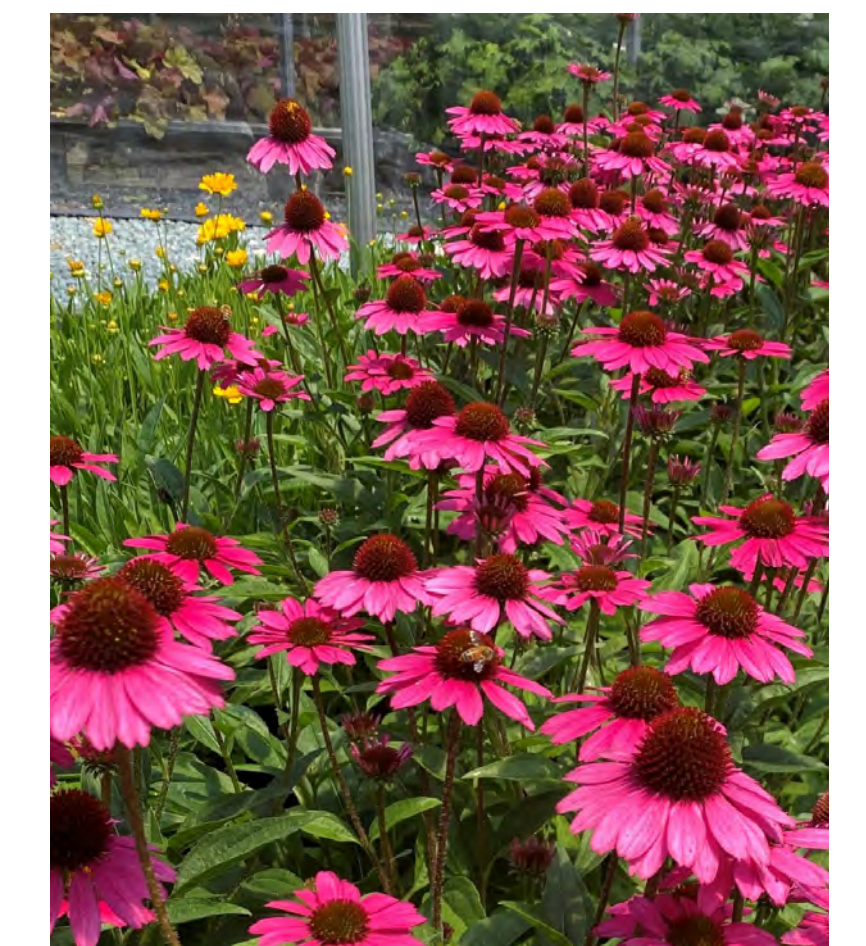
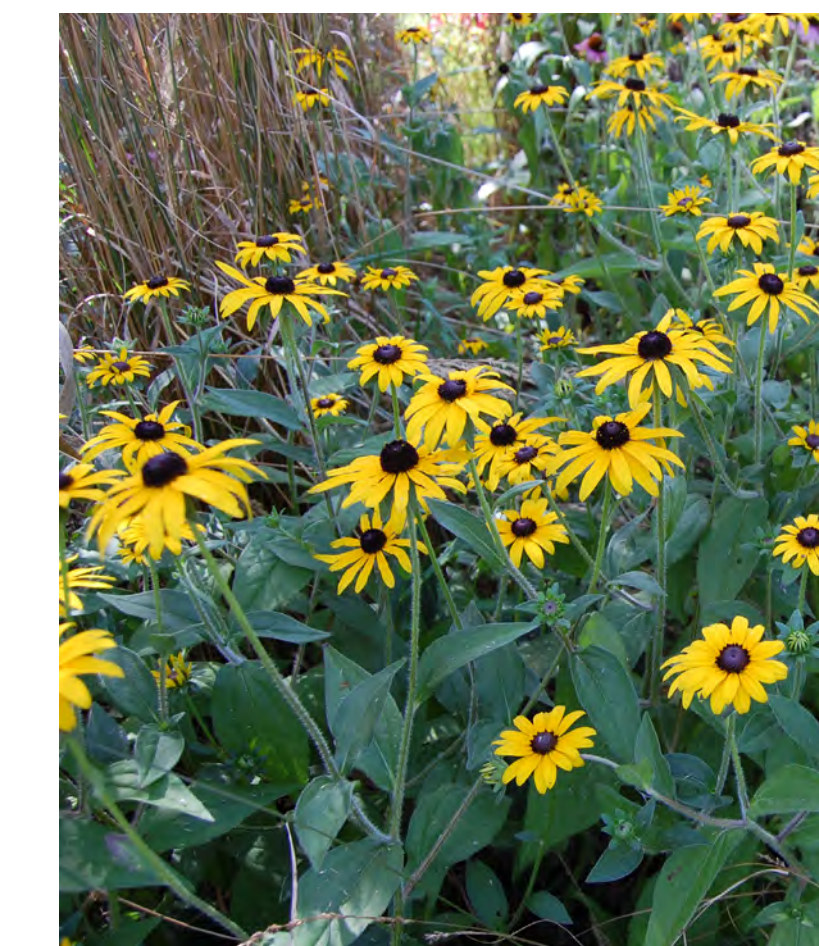
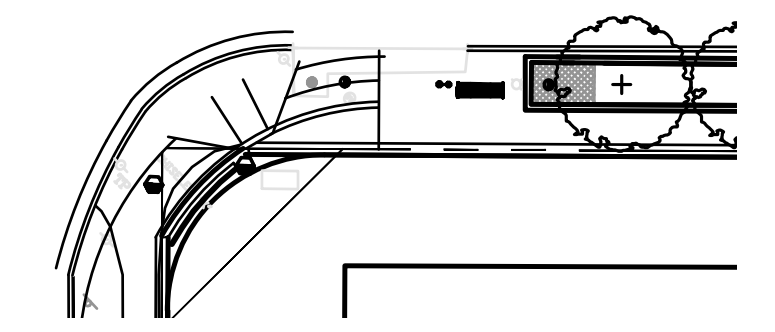
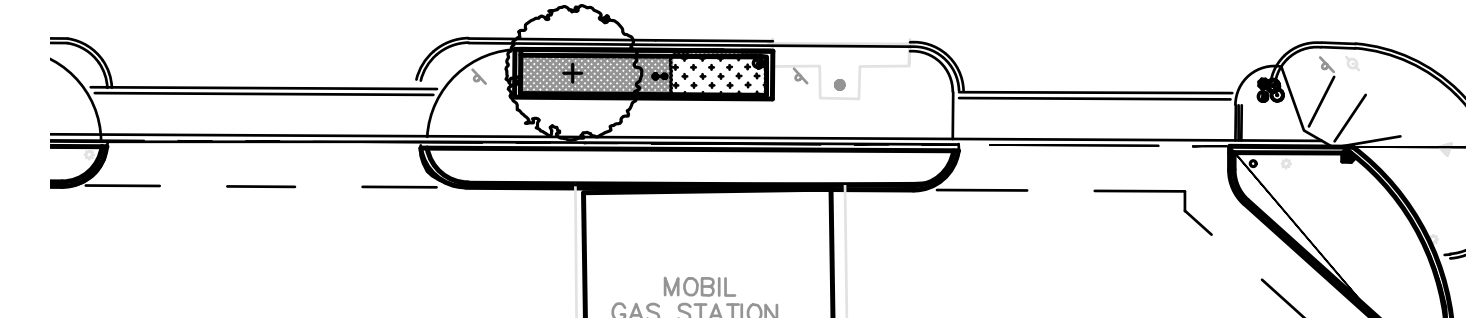
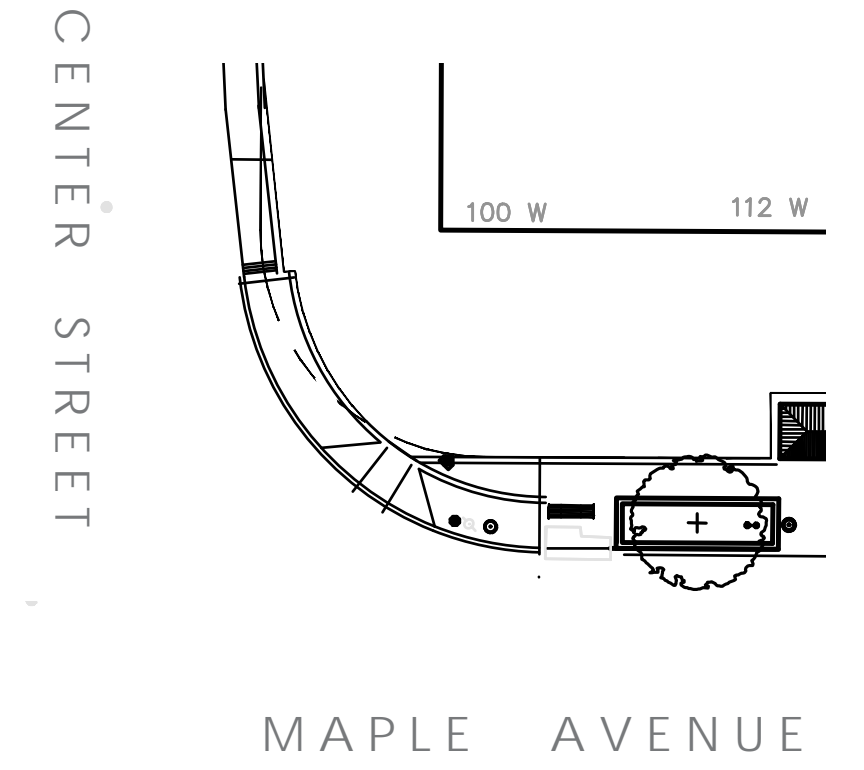
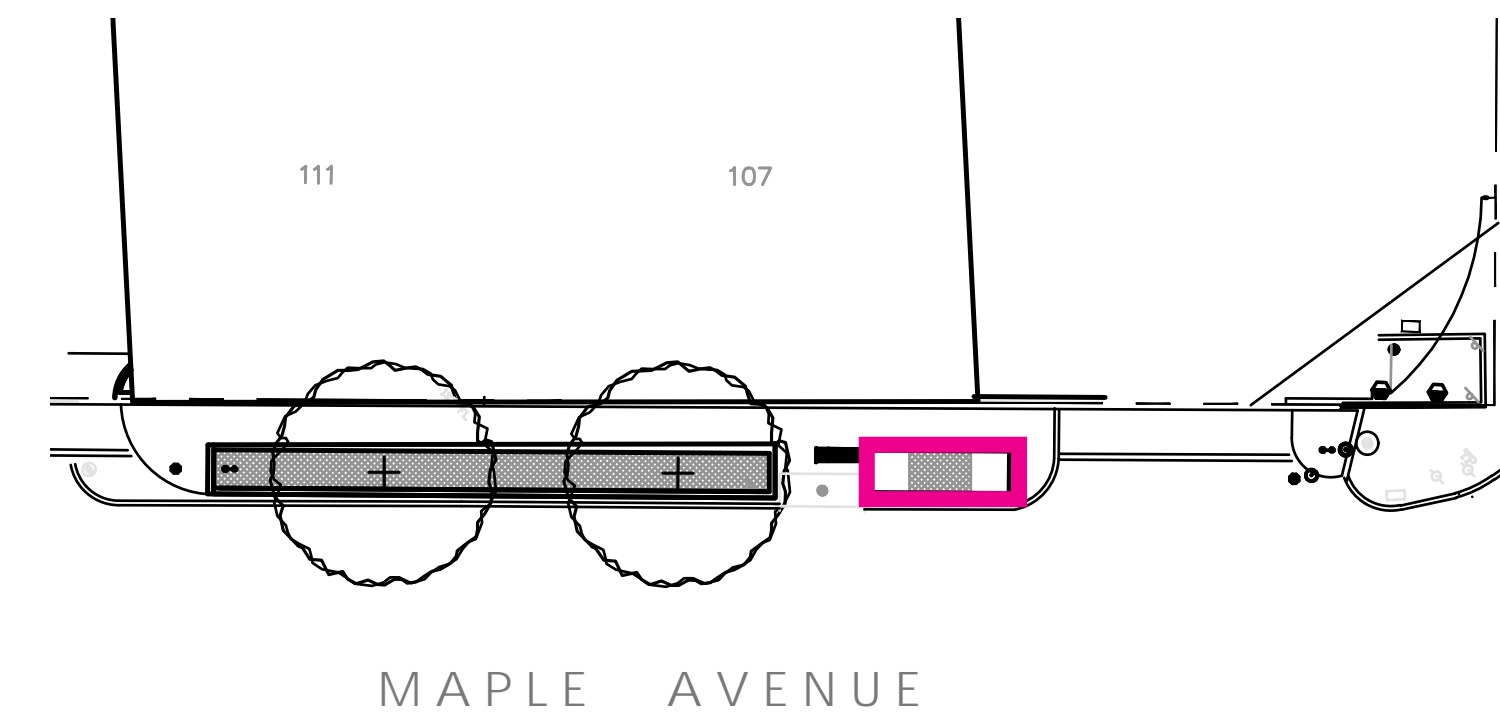

PREPARATION:

- REMOVE EXISTING SHRUBS AND GROUNDCOVERS AS SPECIFIED
- REMOVE EXISTING SURFACE MULCH
- WORK EXPOSED SUBSOIL TO A DEPTH TO 18"
- APPLY NEW SOIL / AMENDED SOIL MIX AS NEEDED TO 1" BELOW BRICK PLANTER EDGE
- WATER SOIL MIN. 4 HOURS BEFORE PLANTING AND REPLENISH SOIL TO BRING TO GRADE
- INSTALL PLANTS AND 2" MULCH

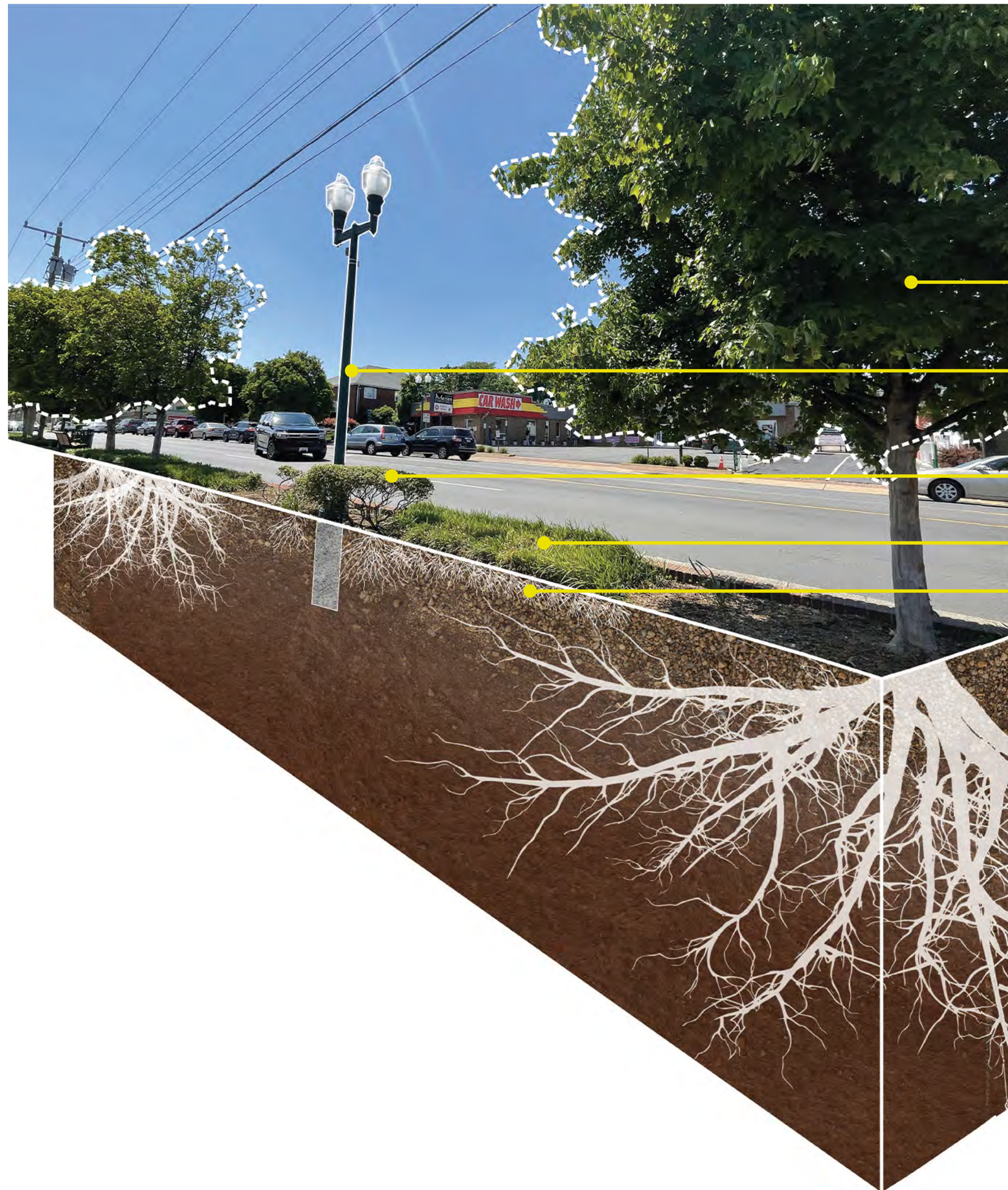

- TREE
- UTILITIES
- SHRUBS
- GROUNDCOVER
- GROUNDCOVER ROOT MAT

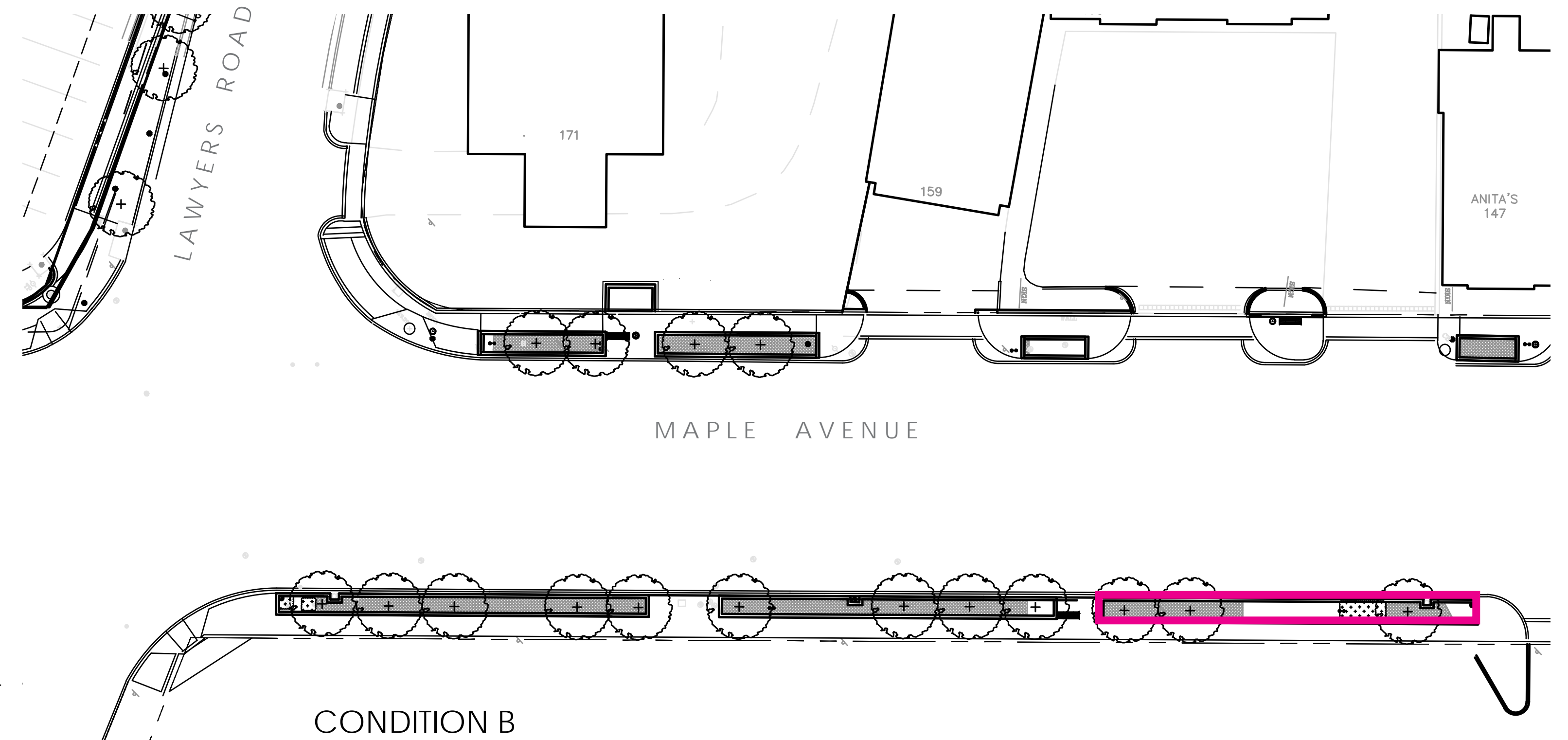

CONDITION B

- TREE CANOPY PROVIDES DAPPLED SHADE FOR SOME PARTS OF DAY
- SUN EXPOSURE BETWEEN OPEN CANOPY



EXISTING TREE TO REMAIN

UNDERSTORY PLANTING IN GAPS BETWEEN TREES

4' RAD. UNDISTURBED AROUND TRUNKS (EXCEPTION FOR BULBS)

18" AGITATED SOIL + AMENDED SOIL (AS NEEDED)

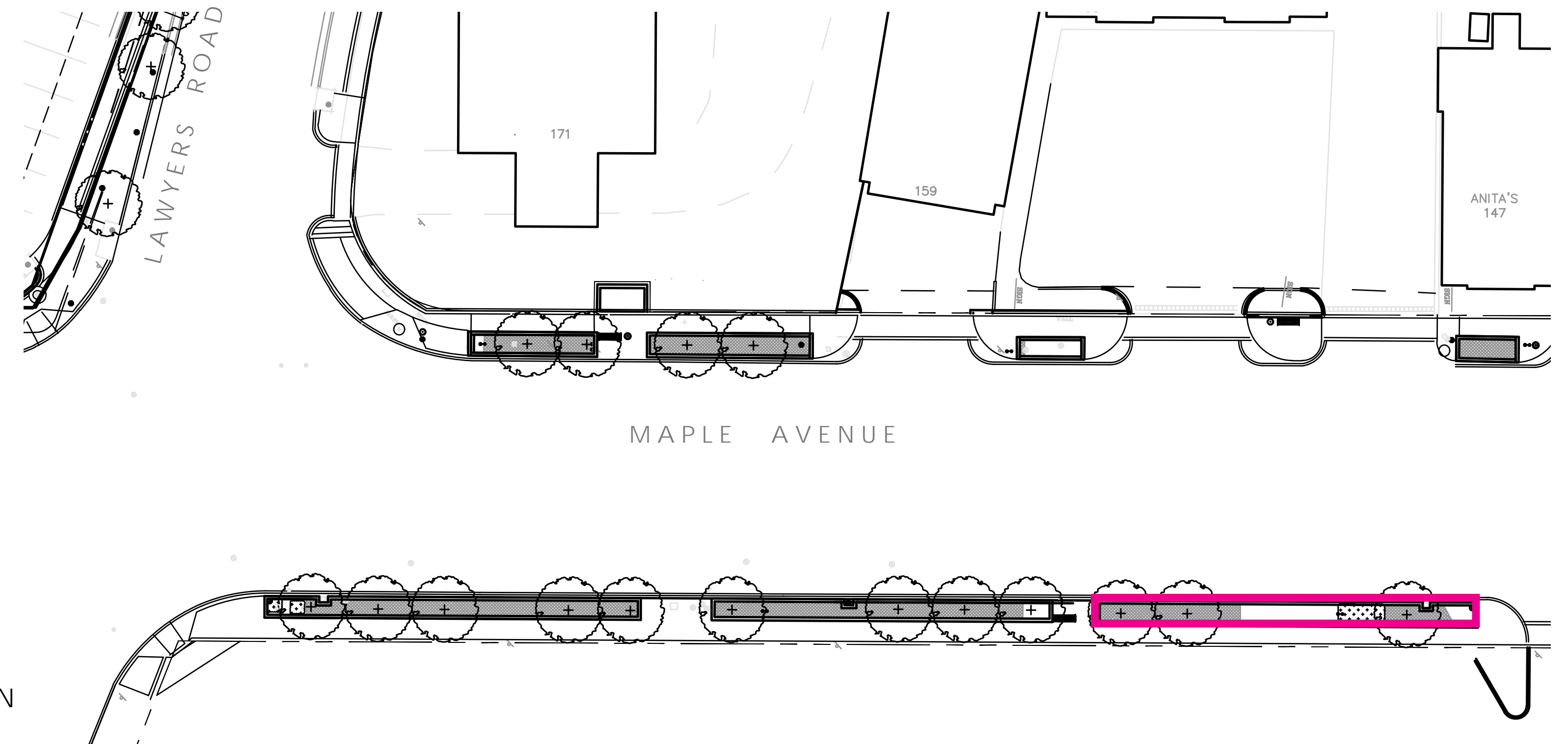

SOIL PREPARATION:

- COMPLETE TOV TREE REMOVALS/REPLACEMENTS PRIOR TO START OF WORK
- COMPLETE ROUTINE TREE CROWN AND ROOT PRUNING AND ROOT AERATION PRIOR TO START OF WORK
- REMOVE EXISTING SHRUBS AND GROUNDCOVERS AS SPECIFIED
- REMOVE EXISTING SURFACE MULCH
- WORK EXPOSED SUBSOIL TO A DEPTH TO 18" WITH CARE TO PROTECT TREE ROOTS
- APPLY NEW SOIL / AMENDED SOIL MIX AS NEEDED TO 1" BELOW BRICK PLANTER EDGE
- WATER SOIL MIN. 4 HOURS BEFORE PLANTING AND REPLENISH SOIL TO BRING TO GRADE
- INSTALL PLANTS AND 2" MULCH

ROUTINE MAINTENANCE BY TOWN OF VIENNA

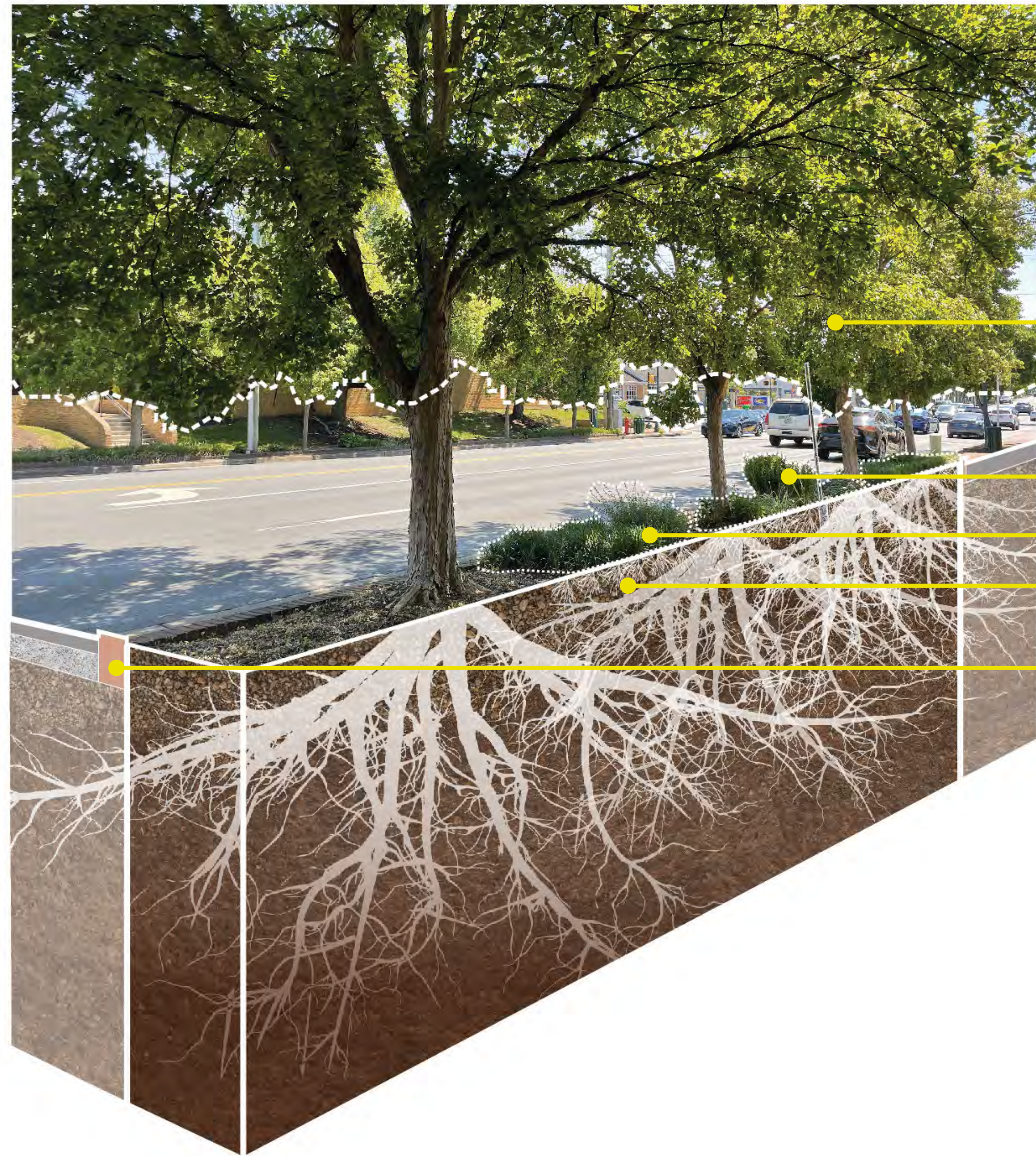

EXISTING TREES TO REMAIN

SHRUBS

GROUNDCOVER

GROUNDCOVER ROOT MAT

BRICK CURB

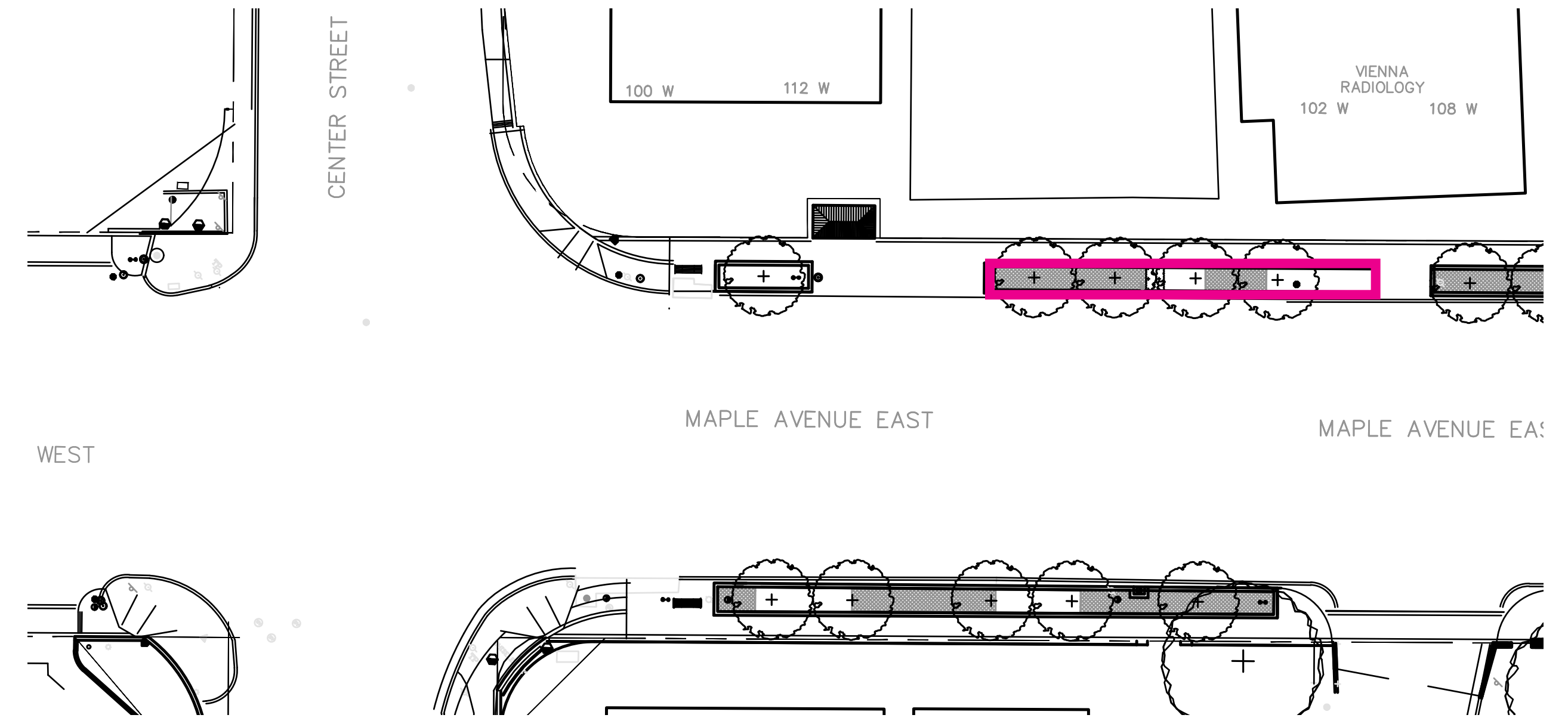

CONDITION C

- CLOSED TREE CANOPY OR BUILDINGS PROVIDE SHADE FOR MOST OF THE DAY
- DENSE CARPETS OF ESTABLISHED LIROPE ARE COMMON
- PLANT SELECTIONS MUST BE FULLY SHADE TOLERANT

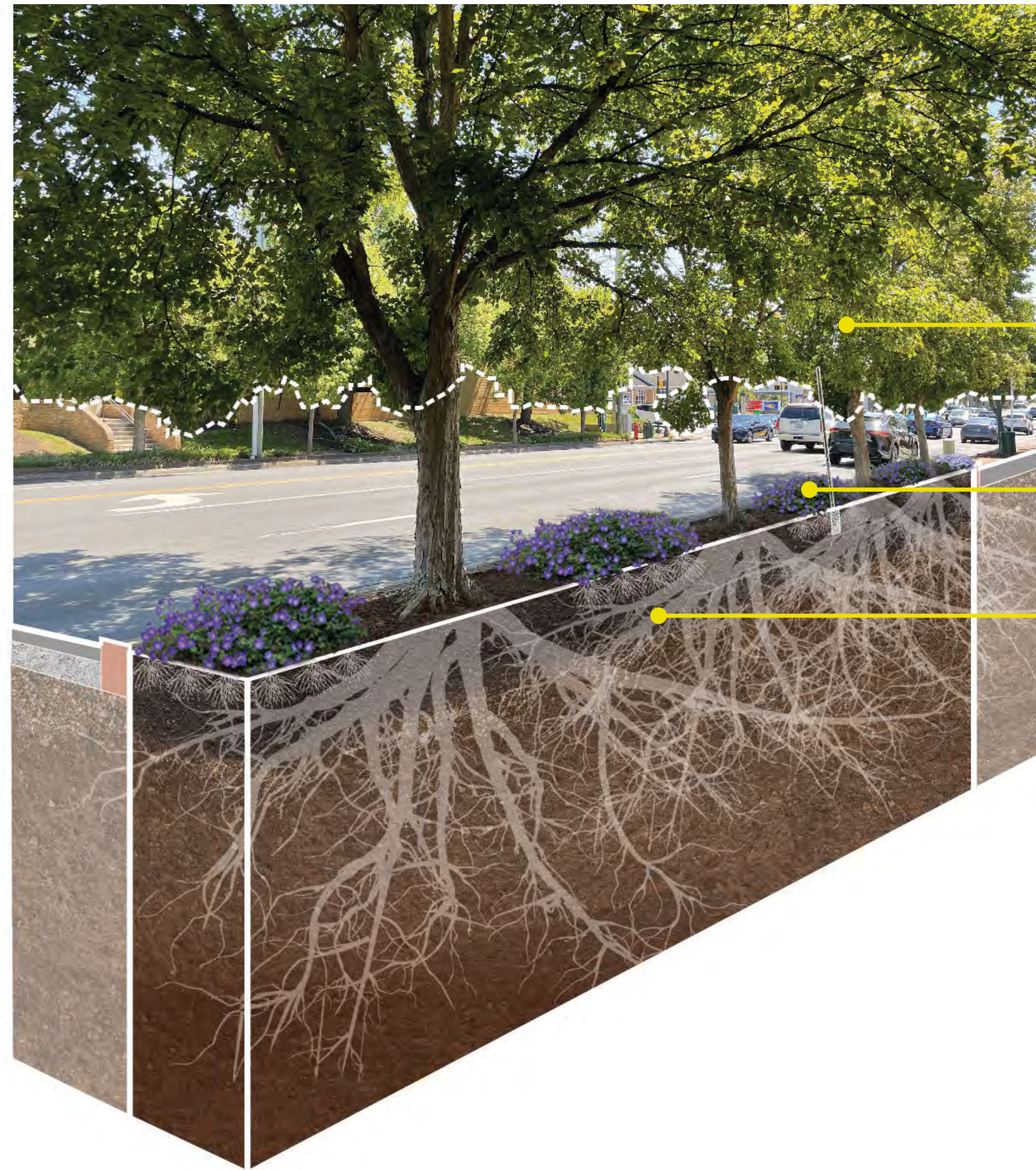

TREES

NEW PERENNIALS AND GROUNDCOVER

18" AGITATED SOIL + AMENDED SOIL (AS NEEDED). PERFORM BY HAND TO AVOID DAMAGE TO TREE ROOTS.

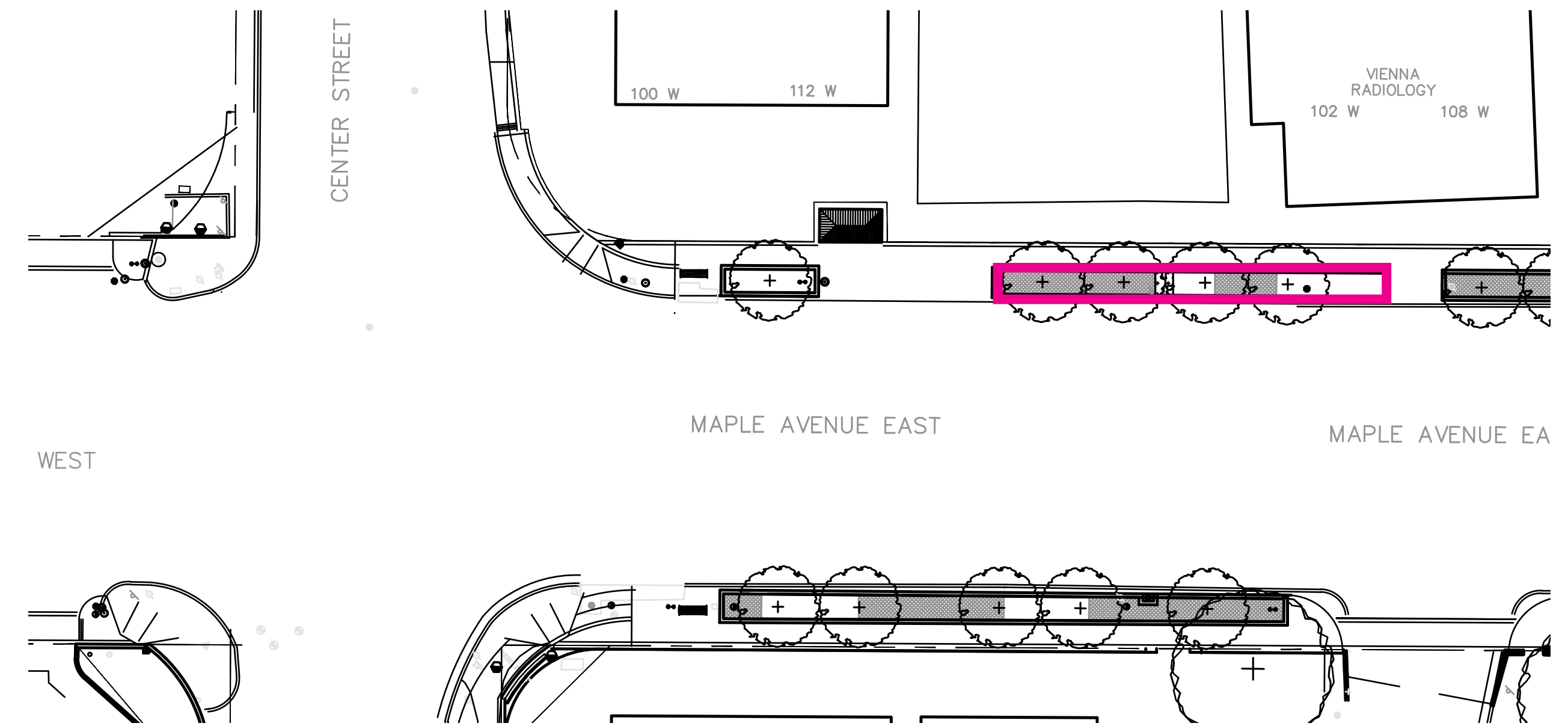

SOIL PREPARATION:

- COMPLETE TOV TREE REMOVALS/REPLACEMENTS PRIOR TO START OF WORK
- COMPLETE ROUTINE TREE CROWN AND ROOT PRUNING AND ROOT AERATION PRIOR TO START OF WORK
- REMOVE EXISTING SHRUBS AND GROUNDCOVERS AS SPECIFIED
- REMOVE EXISTING SURFACE MULCH
- WORK EXPOSED SUBSOIL TO A DEPTH TO 18" WITH CARE TO PROTECT TREE ROOTS
- APPLY NEW SOIL / AMENDED SOIL MIX AS NEEDED TO 1" BELOW BRICK PLANTER EDGE
- WATER SOIL MIN. 4 HOURS BEFORE PLANTING AND REPLENISH SOIL TO BRING TO GRADE
- INSTALL PLANTS AND 2" MULCH

ROUTINE MAINTENANCE BY TOWN OF VIENNA

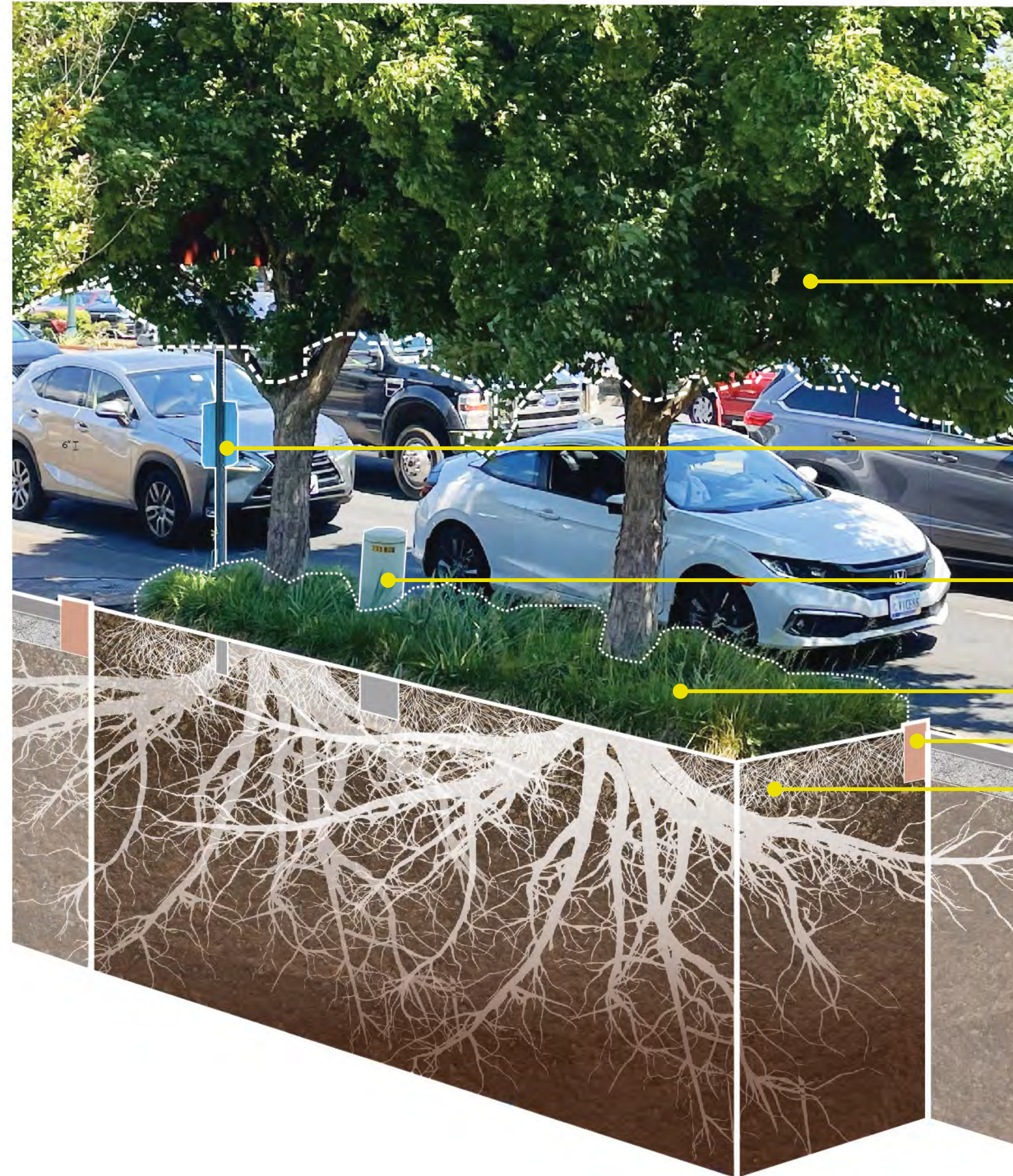

- TREES
- SIGNS/STREETSCAPE ACCESSORIES
- UTILITIES
- GROUNDCOVER
- BRICK CURB
- GROUNDCOVER ROOT MAT

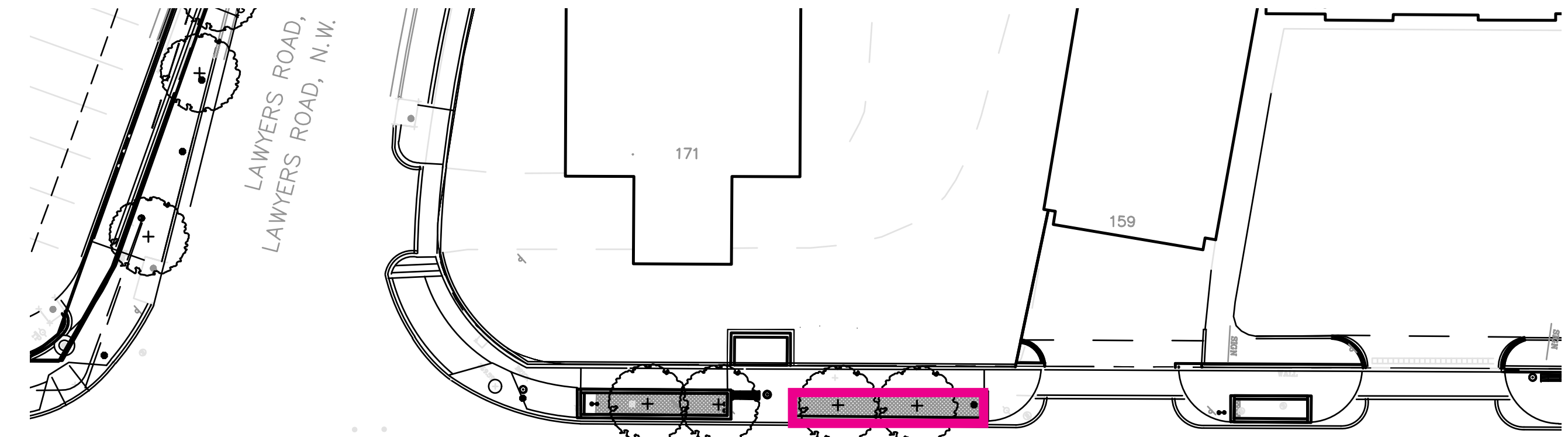

MAPLE AVENUE WEST

MAPLE AVENUE

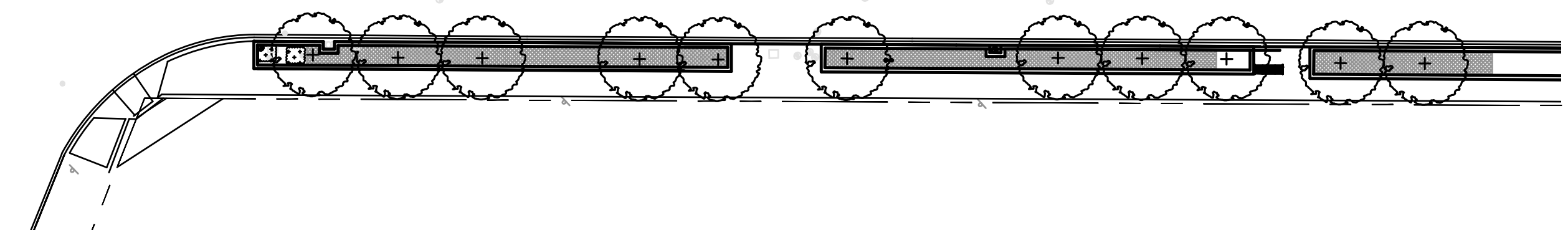

CONDITION D

- EXISTING TREES WITH DENSE SURFACE ROOTS AND UTILITIES LIMIT GROWING AREA, IN ADDITION TO DENSE SHADE CONDITIONS
- REMOVAL OF EXISTING PLANTING AND REPLACEMENT WITH NEW MATERIAL RISKS DAMAGE TO EXISTING TREES AND UTILITIES
- REMOVAL OF THICK LIRIOPE ROOT MATTING WILL RESULT IN SOIL VOIDS REQUIRING ADDITIONAL SOIL
- WORK IN THESE CONDITIONS MUST BE DONE BY HAND
- PLANT PALETTE IS LIMITED BY SURFACE AND SUBSURFACE CONDITIONS

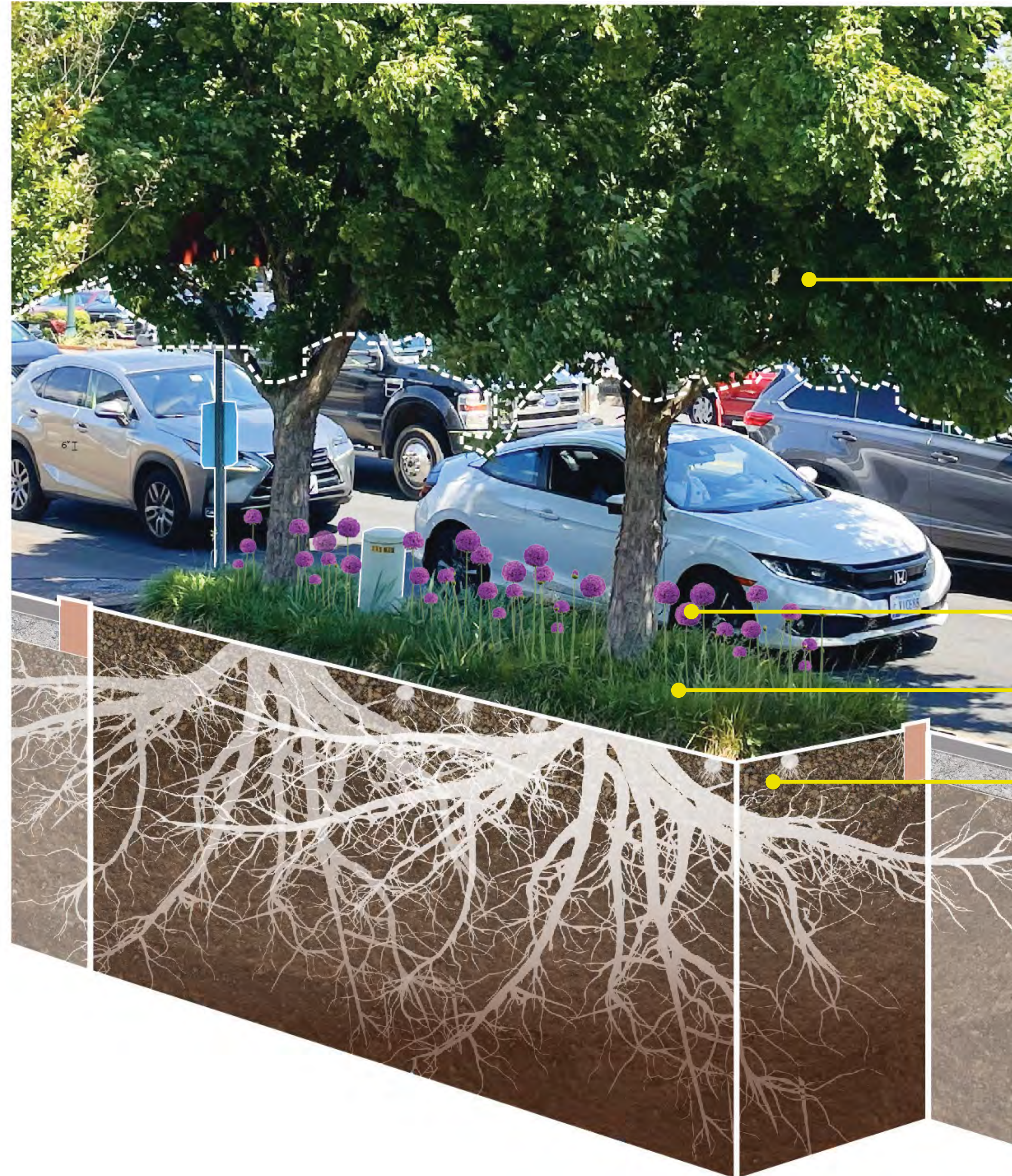

EXISTING TREES TO REMAIN

INTERPLANT BULBS WITHIN EXISTING GROUNDCOVER

EXISTING GROUNDCOVER TO REMAIN

GROUNDCOVER ROOT MAT

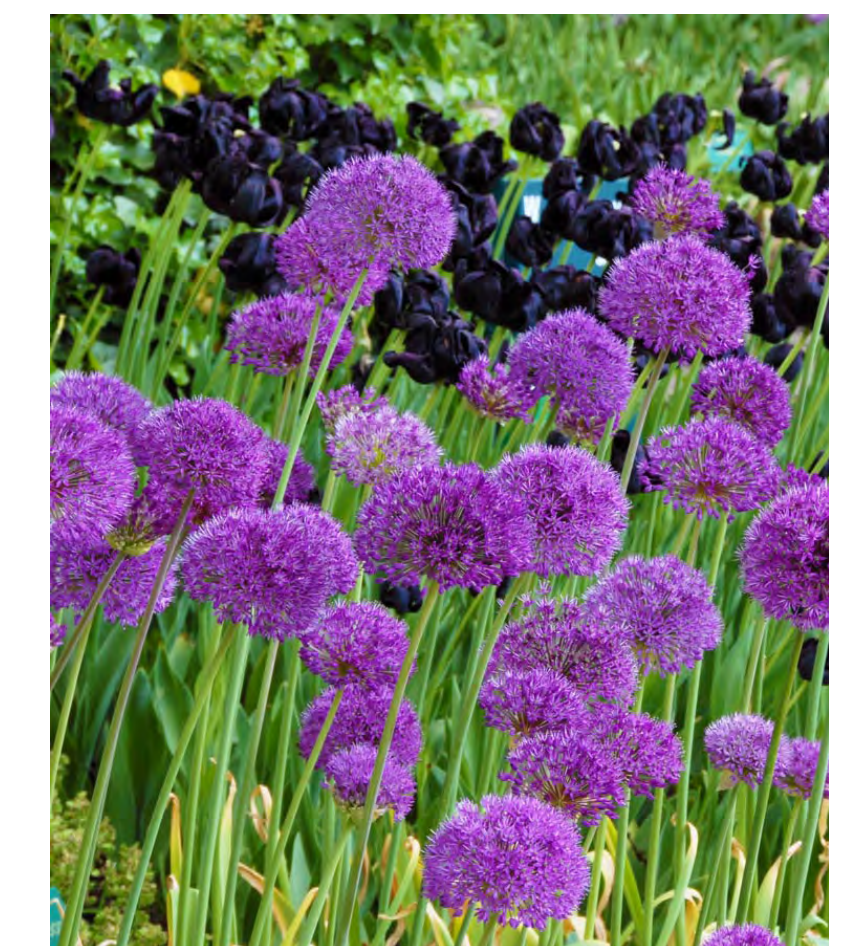
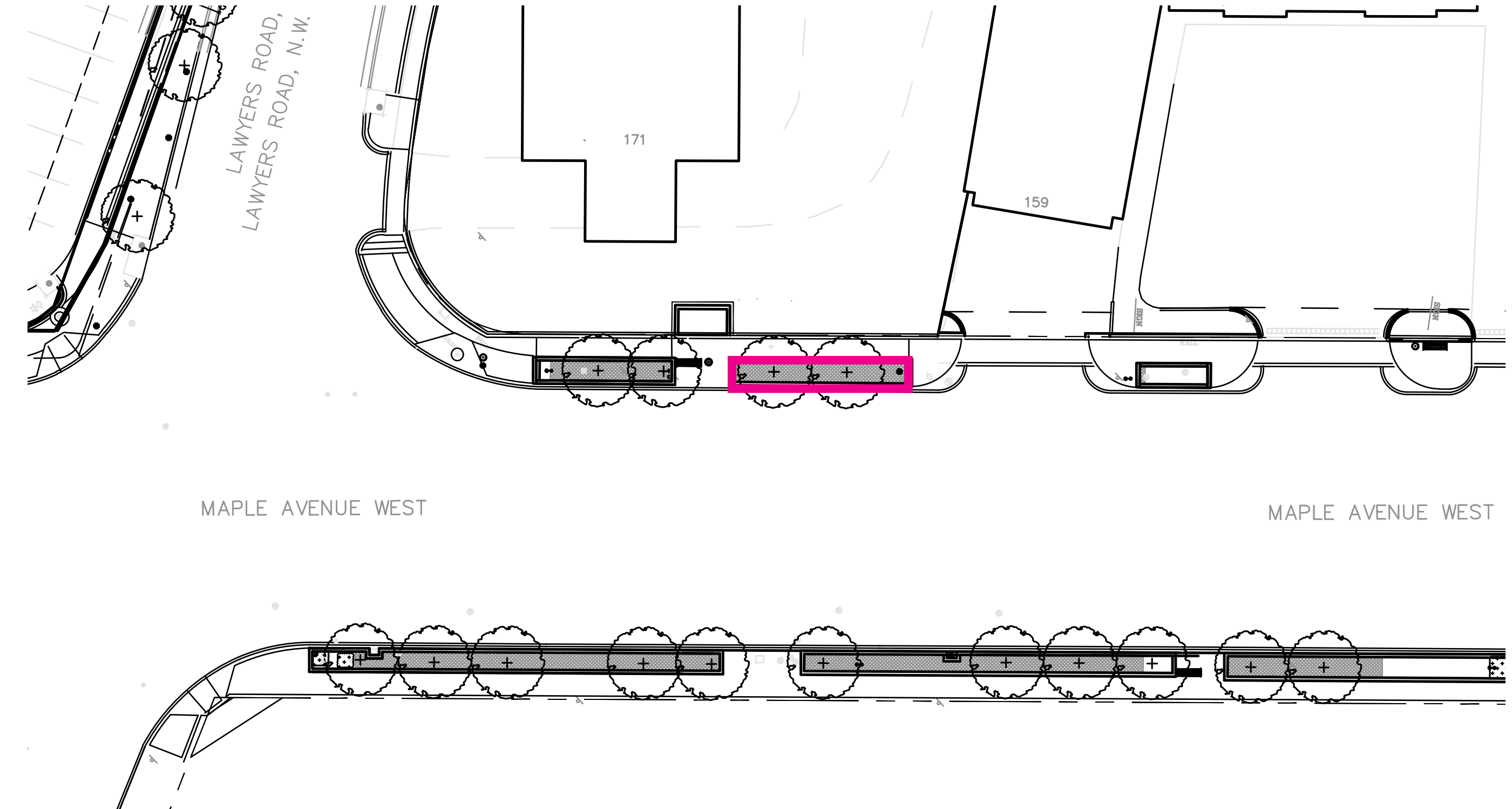

SOIL PREPARATION:

- COMPLETE TOV TREE REMOVALS/REPLACEMENTS PRIOR TO START OF WORK
- COMPLETE ROUTINE TREE CROWN AND ROOT PRUNING AND ROOT AERATION PRIOR TO START OF WORK
- REMOVE EXISTING SHRUBS AND GROUNDCOVERS AS SPECIFIED
- REMOVE EXISTING SURFACE MULCH WHERE EXPOSED
- WATER SOIL MIN. 4 HOURS BEFORE PLANTING
- INTERPLANT BULBS WITHIN EXISTING ESTABLISHED GROUNDCOVER

ROUTINE MAINTENANCE BY TOWN OF VIENNA

EXAMPLE PLANTING PLAN - MAPLE AVE

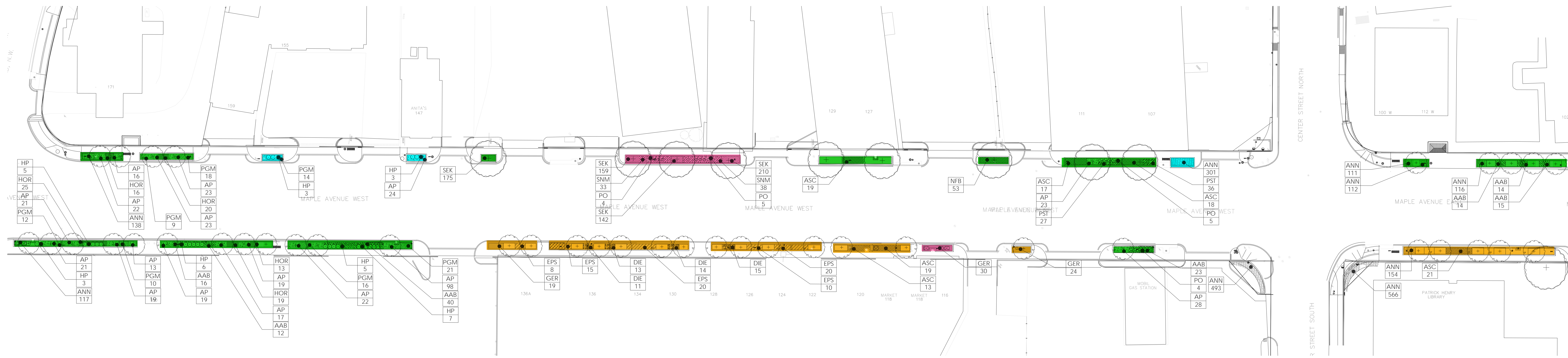

2023-05-25 17:29

PLANT SCHEDULE							
SHRUBS	QTY	BOTANICAL NAME	COMMON NAME	SIZE	TYPE	SPACING	REMARKS
HP	32	HYPERICUM PROLIFICUM	SHRUBBY ST. JOHN'S WORT	30" - 36" HT.	CONT.	36" OC	FULL
PO	18	PHYSOCARPUS OPULIFOLIUS 'SMPOTW'	TINY WINE DWARF NINEBARK	30" HT & 36" SPRD	CONT.	42" OC	FULL
GROUND COVERS	QTY	BOTANICAL NAME	COMMON NAME	SIZE	TYPE	SPACING	REMARKS
AP	408	ALLIUM X 'PURPLE SENSATION'	PURPLE SENSATION ORNAMENTAL ONION	-	BULB	12" O.C	
ANN	2,108	ANNUAL	ANNUAL	FLAT	CONT.	6" OC	MATURE
SEK	686	SEDUM KAMTSCHATICUM	ORANGE STONECROP	FLAT	FLAT	6" OC	MATURE
PERENNIALS	QTY	BOTANICAL NAME	COMMON NAME	SIZE	TYPE	SPACING	REMARKS
ASC	107	ASTER CORDIFOLIUS	BLUE WOOD ASTER	#1	CONT.	24" OC	MATURE
AAB	134	ASTILBE X ARENSII 'BRIDAL VEIL'	BRIDAL VEIL FALSE SPIREA	#1	CONT.	18" OC	MATURE
DIE	53	DICENTRA EXIMIA	FRINGED BLEEDING HEART	#1	CONT.	18" OC	MATURE
EPS	73	ECHINACEA PURPUREA 'SENSATION PINK'	PURPLE CONEFLOWER	#1	CONT.	24" OC	MATURE
GER	73	GERANIUM X 'ROZANNE'	ROZANNE CRANE'S BILL	#1	CONT.	18" OC	MATURE
HOR	93	HELLEBORUS ORIENTALIS	ORIENTAL HELLEBORE	#1	CONT.	15" OC	MATURE
NFB	53	NEPETA X FAASSENII 'WALKERS LOW'	HYBRID CATMINT	#1	CONT.	15" OC	MATURE
PGM	100	PHLOX GLABERRIMA 'MORRIS BERD'	SMOOTH PHLOX	#1	CONT.	18" OC	MATURE
PST	63	PHLOX STOLONIFERA	CREEPING PHLOX	#1	CONT.	12" O.C	MATURE
SNM	71	SALVIA NEMEROSA 'MAY NIGHT'	MAY NIGHT SAGE	#1	CONT.	18" OC	MATURE

- CONDITION A
- CONDITION B
- CONDITION C
- CONDITION D

MAPLE AVE & CHURCH ST STREETScape

EXAMPLE PLANTING PLAN - CHURCH ST

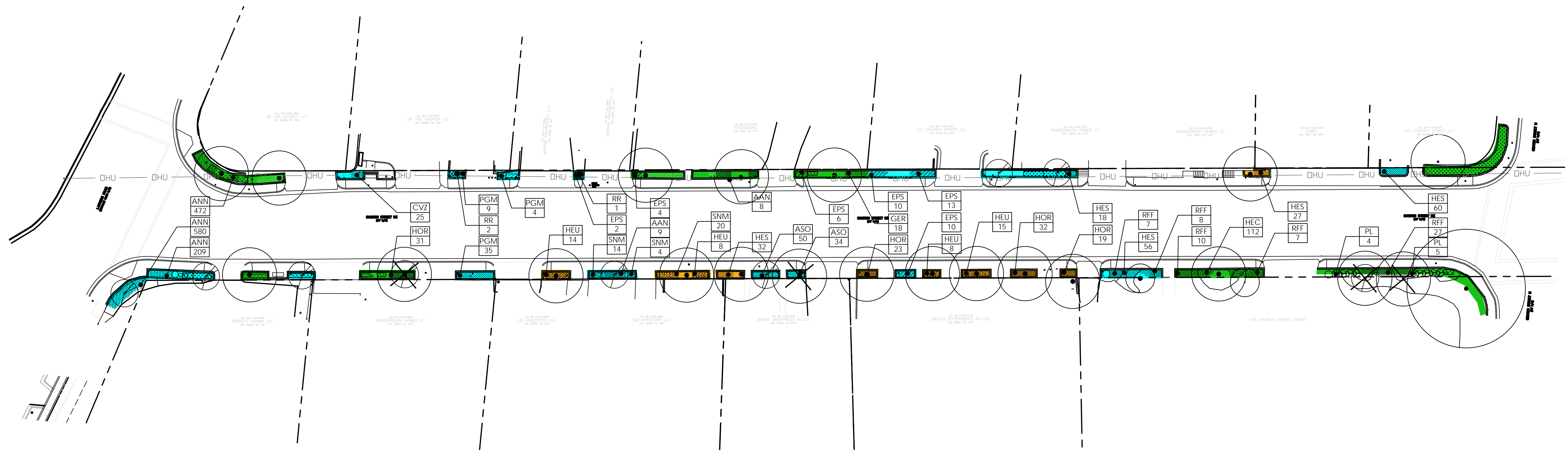

PLANT SCHEDULE CHURCH ST

SHRUBS	QTY	BOTANICAL NAME	COMMON NAME	SIZE	TYPE	SPACING	REMARKS
PL	9	PRUNUS LAUROCERASUS 'OTTO LUYKEN'	OTTO LUYKENS LAUREL	30-36" HT.	CONT.	48" OC	FULL
RR	3	ROSA RUGOSA 'DWARF PAVEMENT'	DWARF PAVEMENT ROSE	24"-30" SPR.	CONT.	30" OC	FULL
GROUND COVERS	QTY	BOTANICAL NAME	COMMON NAME	SIZE	TYPE	SPACING	REMARKS
ANN	1,261	ANNUAL	ANNUAL	FLAT	CONT.	6" OC	MATURE
PERENNIALS	QTY	BOTANICAL NAME	COMMON NAME	SIZE	TYPE	SPACING	REMARKS
ASO	84	ASTER OBLONGIFOLIUS 'OCTOBER SKIES'	FRAGRANT ASTER	#1	CONT.	12" O.C	MATURE
AAN	22	ASTILBE X ARENDII 'NEMO'	FANAL FALSE SPIREA	#1	CONT.	24" OC	MATUER
CVZ	25	COREOPSIS VERTICILLATA 'ZAGREB'	ZAGREB TICKSEED	#1	CONT.	12" O.C	MATURE
EPS	45	ECHINACEA PURPUREA 'SENSATION PINK'	PURPLE CONEFLOWER	#1	CONT.	24" OC	MATURE
GER	18	GERANIUM X 'ROZANNE'	ROZANNE CRANE'S BILL	#1	CONT.	18" OC	MATURE
HOR	105	HELLEBORUS ORIENTALIS	ORIENTAL HELLEBORE	#1	CONT.	15" OC	MATURE
HES	193	HEMEROCALLIS X 'STELLA DE ORO'	STELLA DE ORO DAYLILY	#1	CONT.	12" O.C	MATURE
HEC	112	HEUCHERA X 'CITRONELLE'	CITRONELLE YELLOW CORAL BELLS	#1	CONT.	12" OC	MATURE
HEU	45	HEUCHERA X 'STEEL CITY'	STEEL CITY CORAL BELLS	#1	CONT.	24" OC	MATURE
PGM	48	PHLOX GLABERRIMA 'MORRIS BERD'	SMOOTH PHLOX	#1	CONT.	18" OC	MATURE
RFF	59	RUDBECKIA FULGIDA VAR. FULGIDA	BLACK EYED SUSAN	#1	CONT.	24" OC	MATURE
SNM	46	SALVIA NEMEROSA 'MAY NIGHT'	MAY NIGHT SAGE	#1	CONT.	18" OC	MATURE

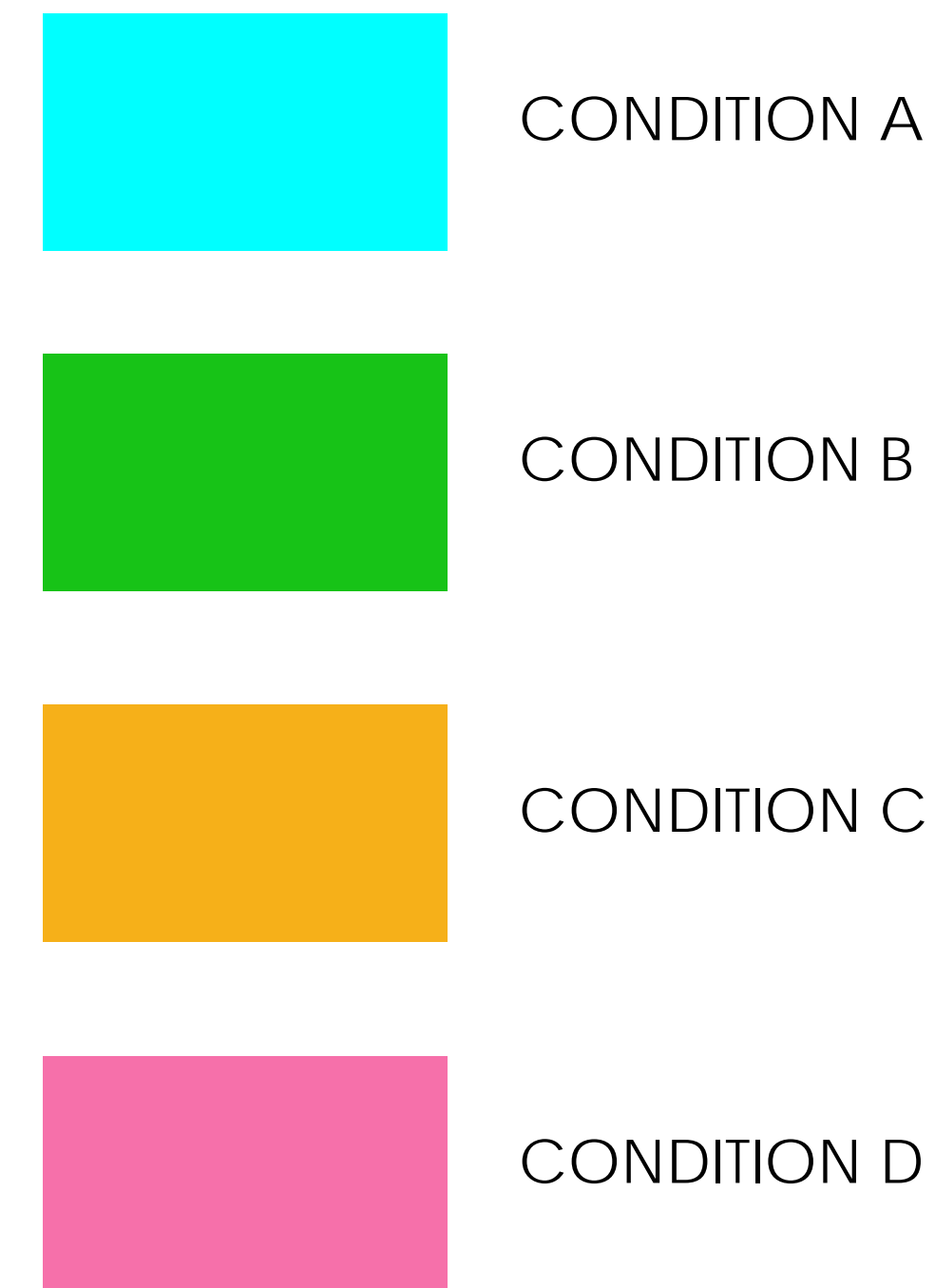

MAPLE AVE & CHURCH ST STREETSCAPE

NO ANNUALS

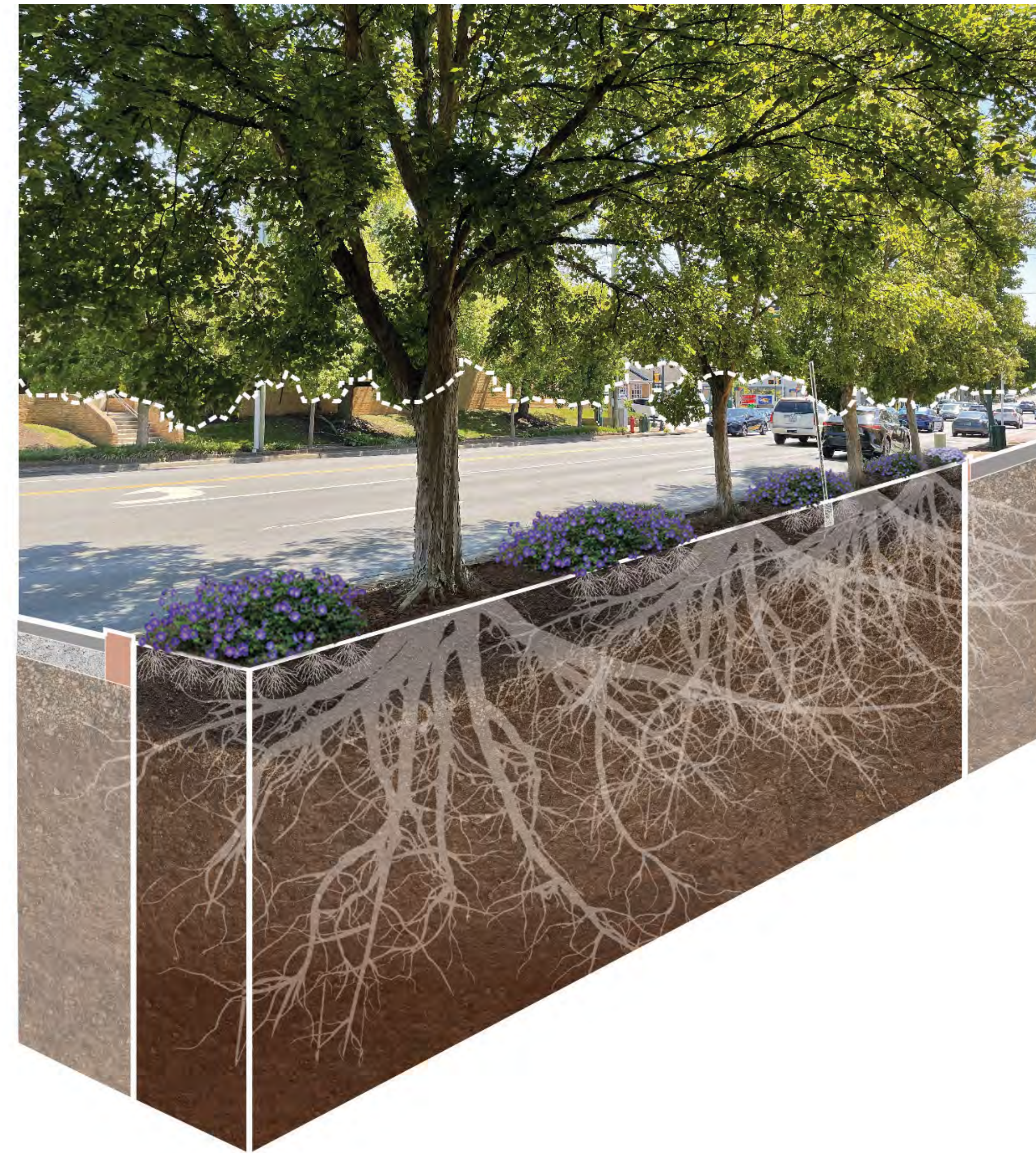

ANNUALS TO ACCENT PLANTER EDGES AT INTERSECTIONS

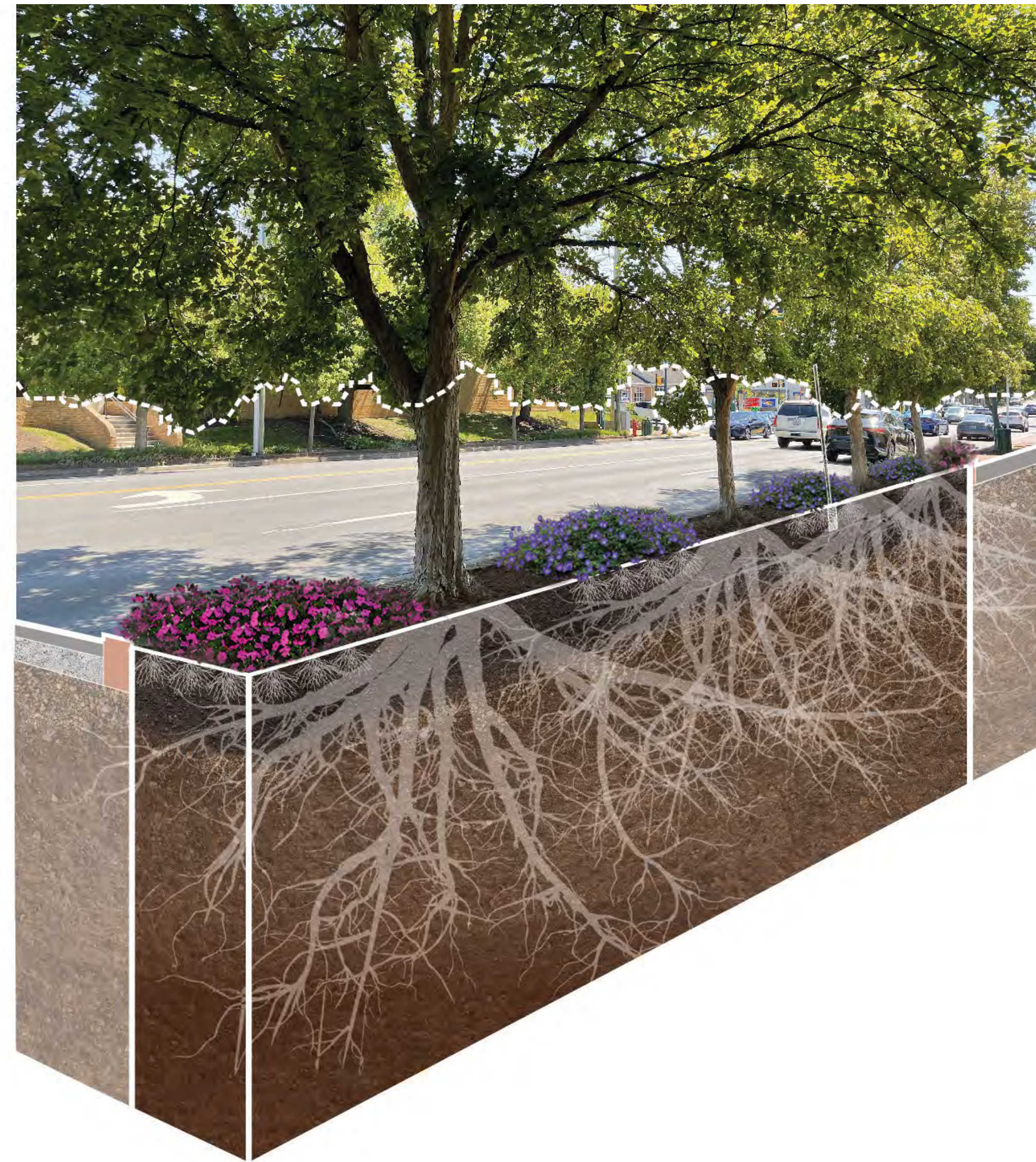

ANNUAL ARRANGEMENTS IN POTS AT STRATEGIC LOCATIONS

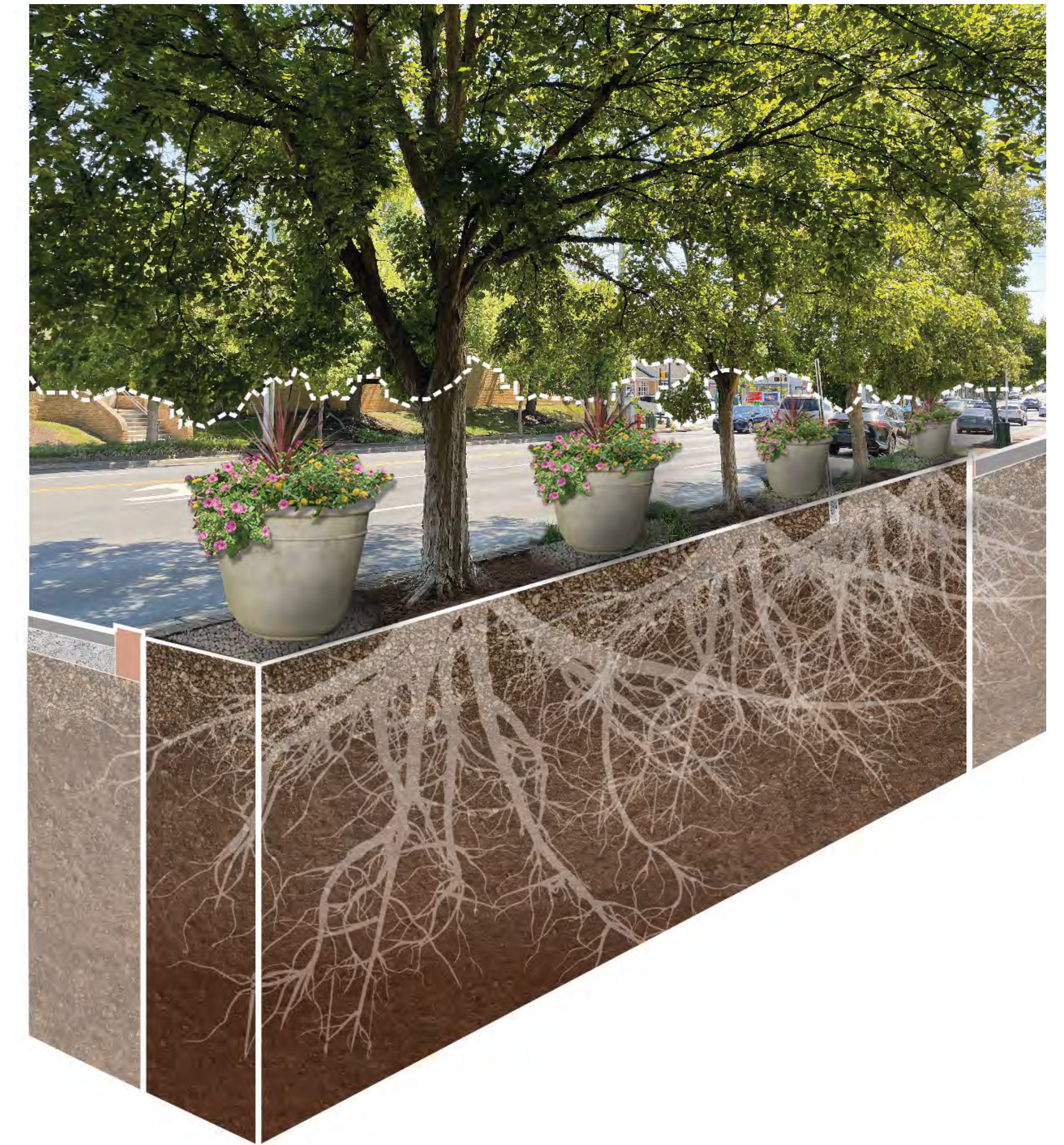



PLANT LIST

Project: Maple Avenue & Church Street Streetscape
 Ecoregion: Piedmont Uplands

Date: 5/24/2023
 Created by: ED
 Revisions by: LW, RK

KEY #	BOTANICAL NAME	COMMON NAME	MATURE HEIGHT	FLOWER COLOR	BLOOM TIME
					J F M A M J J A S O N D
Condition A full sun					
	Amsonia ciliata	Fringed Bluestar	2'		J F M A M J J A S O N D
	Aster oblongifolius 'October Skies'	Fragrant Aster	18-20"		J F M A M J J A S O N D
	Coreopsis verticillata 'Zagreb'	Whorled Tickseed	1-2'		J F M A M J J A S O N D
	Echinacea purpurea 'Sensation Pink'	Purple Coneflower	1-2'		J F M A M J J A S O N D
	Hemerocallis 'Stella de Oro'	Stella de Oro Daylily	1'		J F M A M J J A S O N D
	Hypericum calycinum	Creeping St. Johnswort	1-2'		J F M A M J J A S O N D
	Nepeta x faassenii 'Walker's Low'	Hybrid Catmint	2-3'		J F M A M J J A S O N D
	Penstemon digitalis 'Huskers Red'	White Beardtongue	2-4'		J F M A M J J A S O N D
	Phlox glaberrima 'Morris Berd'	Smooth Phlox	1-2'		J F M A M J J A S O N D
	Pycnanthemum tenuifolium	Slender Mountain Mint	2-3'		J F M A M J J A S O N D
	Rudbeckia fulgida var. fulgida	Black Eyed Susan	2-3'		J F M A M J J A S O N D
	Rudbeckia fulgida var. speciosa	Black Eyed Susan	2-3'		J F M A M J J A S O N D
	Salvia nemerosa 'May Night'	Wood Sage	18-24"		J F M A M J J A S O N D
	Sedum kamtschaticum	Orange Stonecrop	4-8"		J F M A M J J A S O N D
	Sedum sexangulare	Six-sided Stonecrop	4-8"		J F M A M J J A S O N D
	Panicum virgatum 'Shenandoah'	Switchgrass	3'		J F M A M J J A S O N D
	Schizachyrium scoparium 'Standing Ovation'	Little Bluestem	3-4'		J F M A M J J A S O N D
Condition B Part Sun/Part Shade					
	Allium cernuum	Nodding Pink Onion	1'		J F M A M J J A S O N D
	Aster cordifolius	Blue Wood Aster	2-3'		J F M A M J J A S O N D
	Astilbe andresii	False Goatsbeard	2-3'		J F M A M J J A S O N D
	Coreopsis auriculata	Mouse Ear Tickseed	1'		J F M A M J J A S O N D
	Dicentra eximia	Wild Bleeding Heart	1-2'		J F M A M J J A S O N D
	Echinacea purpurea 'Sensation Pink'	Purple Coneflower	1-2'		J F M A M J J A S O N D
	Eupatorium coelestinum	Mistflower	2-3'		J F M A M J J A S O N D
	Geranium macrorrhizum	Bigroot Geranium	1'		J F M A M J J A S O N D
	Geranium 'Rozanne'	Rozanne Geranium	1-2'		J F M A M J J A S O N D
	Helleborus niger	Christmas Rose	1'		J F M A M J J A S O N D
	Helleborus orientalis	Lenten Rose	1-2'		J F M A M J J A S O N D
	Heuchera villosa f. purpurea 'Bronze Wave'	Hairy Alumroot	10-18"		J F M A M J J A S O N D
	Heuchera villosa var. macrorrhiza 'Autumn Bride'	Hairy Alumroot	10-18"		J F M A M J J A S O N D
	Heuchera x 'Steel City'	Steel City Alumroot	1-2'		J F M A M J J A S O N D
	Heuchera x 'Citronelle'	Citronelle Alumroot	1-2'		J F M A M J J A S O N D
	Hypericum calycinum	Creeping St. Johnswort	1-2'		J F M A M J J A S O N D
	Monarda bradburiana	Bradbury's Beebalm	1-2'		J F M A M J J A S O N D
	Penstemon digitalis	White Beardtongue	2-4'		J F M A M J J A S O N D
	Phlox stolonifera	Creeping Phlox	6-10"		J F M A M J J A S O N D
	Senecio aureus	Golden Groundsel	1-3'		J F M A M J J A S O N D
Condition C Restricted Growth					
	Lysimachia lanceolata f. purpurea	Lance-leaved Loosestrife	1-2'		J F M A M J J A S O N D
	Phlox stolonifera	Creeping Phlox	6-10"		J F M A M J J A S O N D
	Waldsteinia fragarioides	Barren Strawberry	3-6"		J F M A M J J A S O N D

KEY #	BOTANICAL NAME	COMMON NAME	MATURE HEIGHT	FLOWER COLOR	BLOOM TIME
					J F M A M J J A S O N D
Bulbs					
	Allium 'Purple Sensation'	Ornamental Onion	2-3'		J F M A M J J A S O N D
	Crocus tommasinianus 'Ruby Giant'	Snow Crocus	4-6"		J F M A M J J A S O N D
	Galanthus nivalis	Snowdrops	6-8"		J F M A M J J A S O N D
	Ipheion uniflorum	Spring Starflower	4-6"		J F M A M J J A S O N D
	Iris reticulata	Reticulated Iris	4-6"		J F M A M J J A S O N D
	Muscari armenicum	Grape Hyacinth	4-6"		J F M A M J J A S O N D
	Narcissus 'Minnow'	Daffodil	1-2'		J F M A M J J A S O N D
	Narcissus 'Thalia'	Triandrus Daffodil	1-2'		J F M A M J J A S O N D
	Scilla siberica	Siberian Squill	4-6"		J F M A M J J A S O N D
Shrubs					
	Buddleja 'Lo and Behold Blue Chip'	Lo and Behold 'Blue Chip' Butterflybush	2-3'		
	Diervilla sessilifolia	Southern Bush Honeysuckle	1-3'		J F M A M J J A S O N D
	Hydrangea arborescens 'Invincibelle Wee White'	Wild Hydrangea	2-3'		J F M A M J J A S O N D
	Hydrangea paniculata 'Flare'	Peegee Hydrangea	3'		J F M A M J J A S O N D
	Hypericum prolificum	Shrubby St. Johnswort	3'		J F M A M J J A S O N D
	Physocarpus opulifolius 'Tiny Wine'	Dwarf Ninebark	2-3'		J F M A M J J A S O N D
	Rosa 'Coral'	Flower Carpet Coral Rose	2-3'		J F M A M J J A S O N D
	Rosa rugosa 'Dwarf Pavement'	Dwarf Pavement Rose	2-3'		J F M A M J J A S O N D
	Spiraea japonica	Japanese Spiraea	3-6'		J F M A M J J A S O N D

UNIQUE CONDITIONS:

- SHADE
- EXTENSIVE ROOTS
- STREETSCAPE ENVIRONEMNT
- DRY
- SALT
- TRAMPLING AT TOWN EVENTS

POTENTIAL EXTENSION TO NUTLEY ST

PROJECT SCOPE



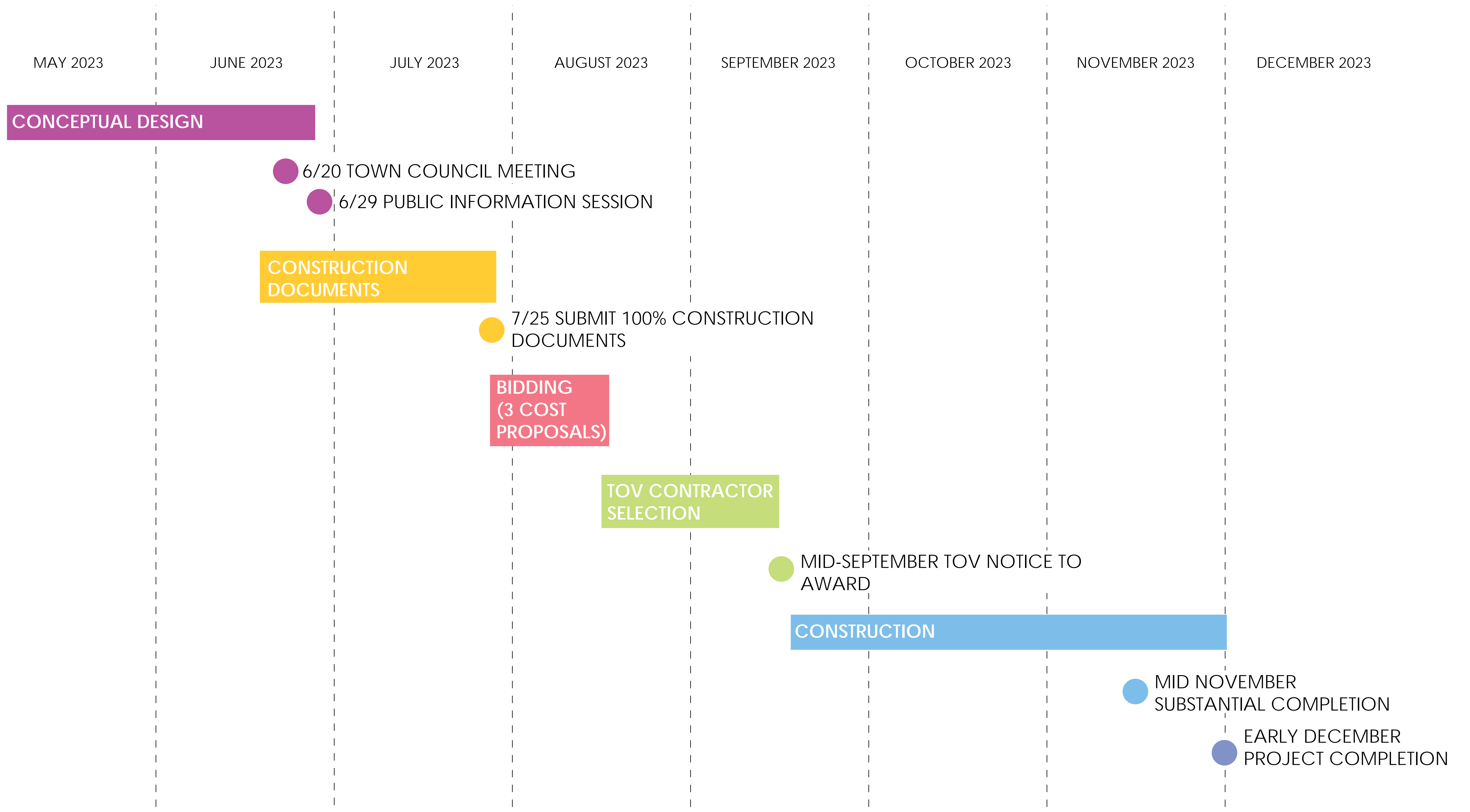

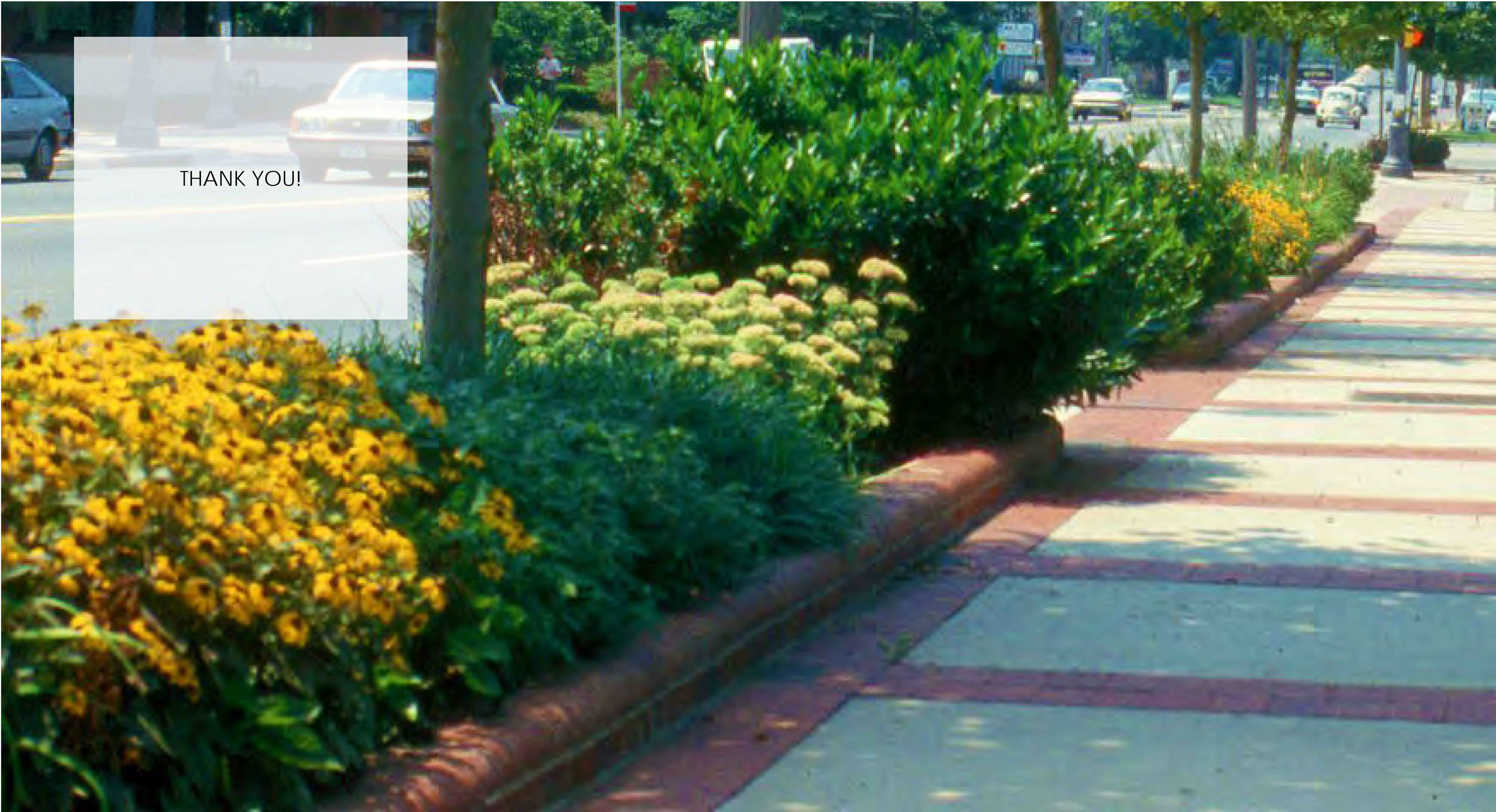

THANK YOU!